

6 x 6 x 12 SERIES 610

ENCLOSED IMPELLER

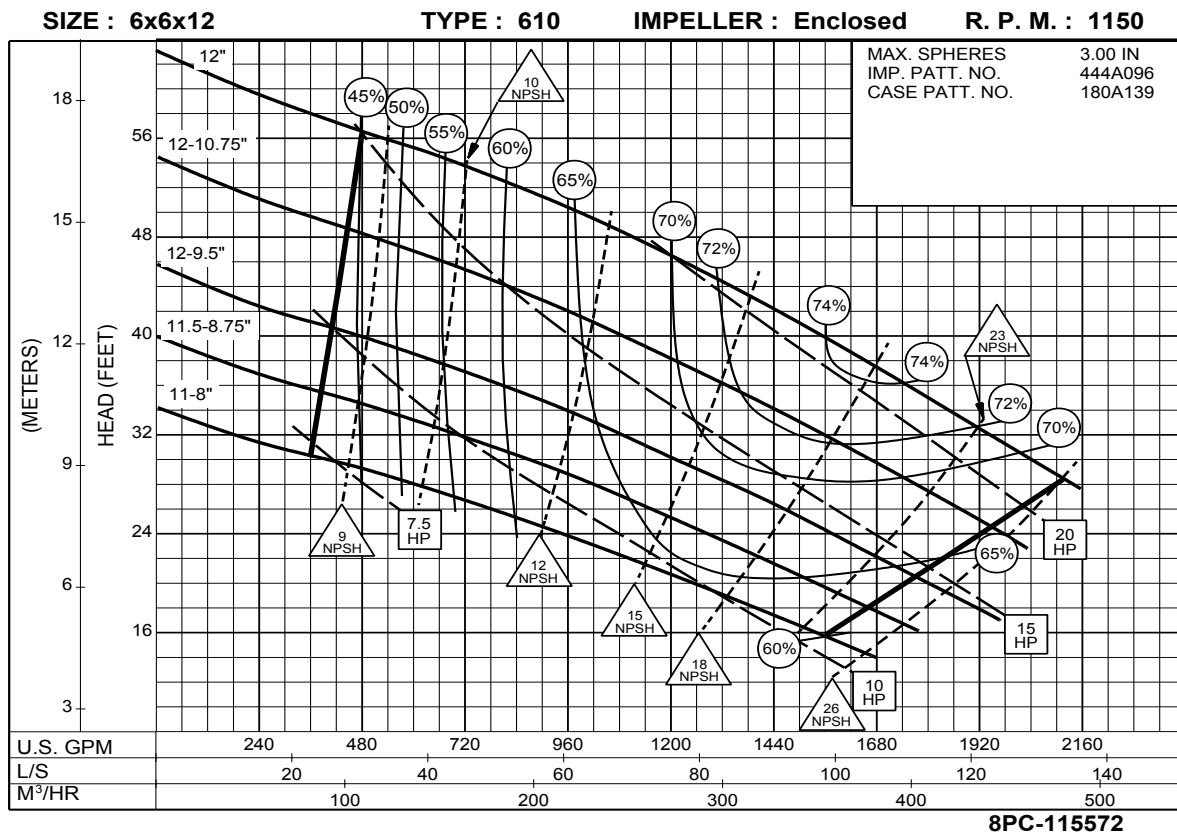
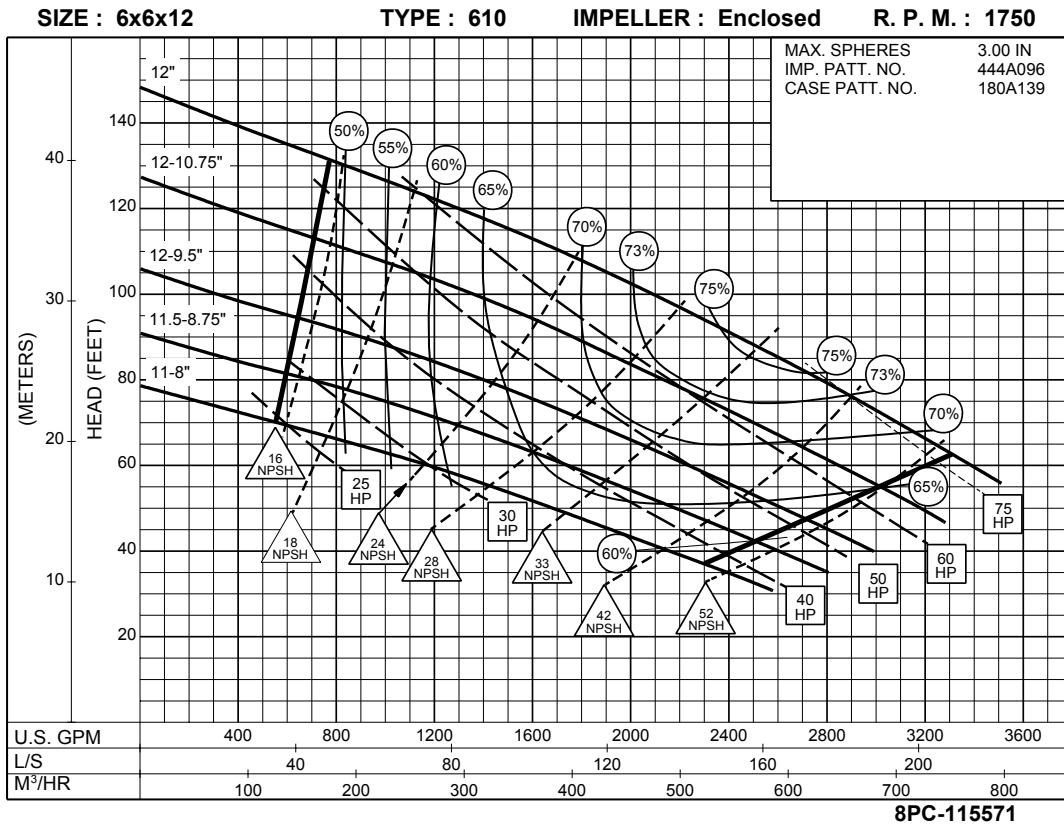

6 x 6 x 12B SERIES 610

ENCLOSED IMPELLER

SIZE : 6x6x12B TYPE : 610 IMPELLER : Enclosed R. P. M. : 1750

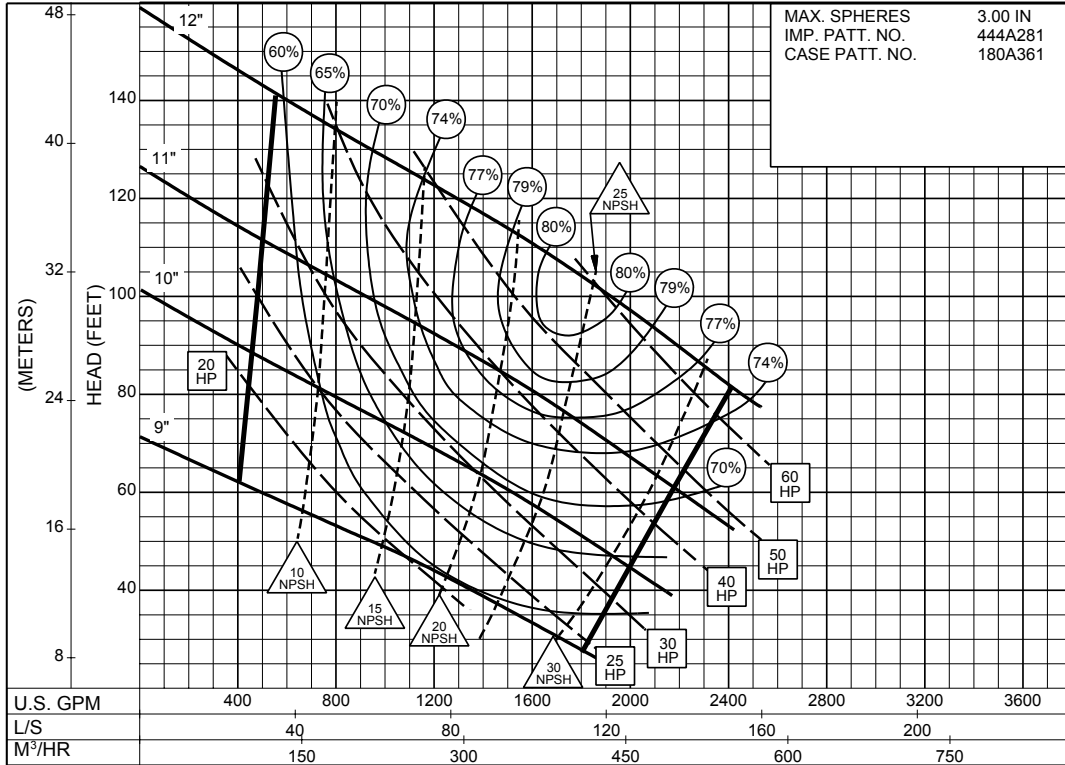

8PC-144962

1750
RPM

SIZE : 6x6x12B TYPE : 610 IMPELLER : Enclosed R. P. M. : 1150

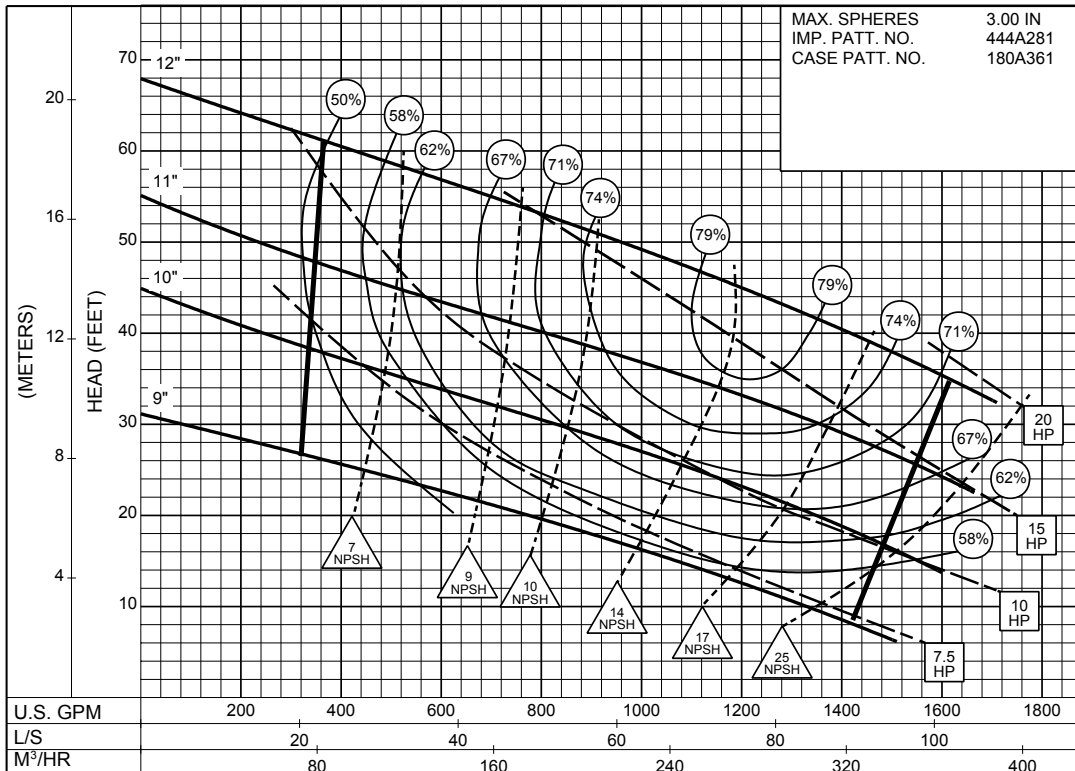

8PC-151595

1150
RPM

6 x 6 x 12B SERIES 610

ENCLOSED IMPELLER

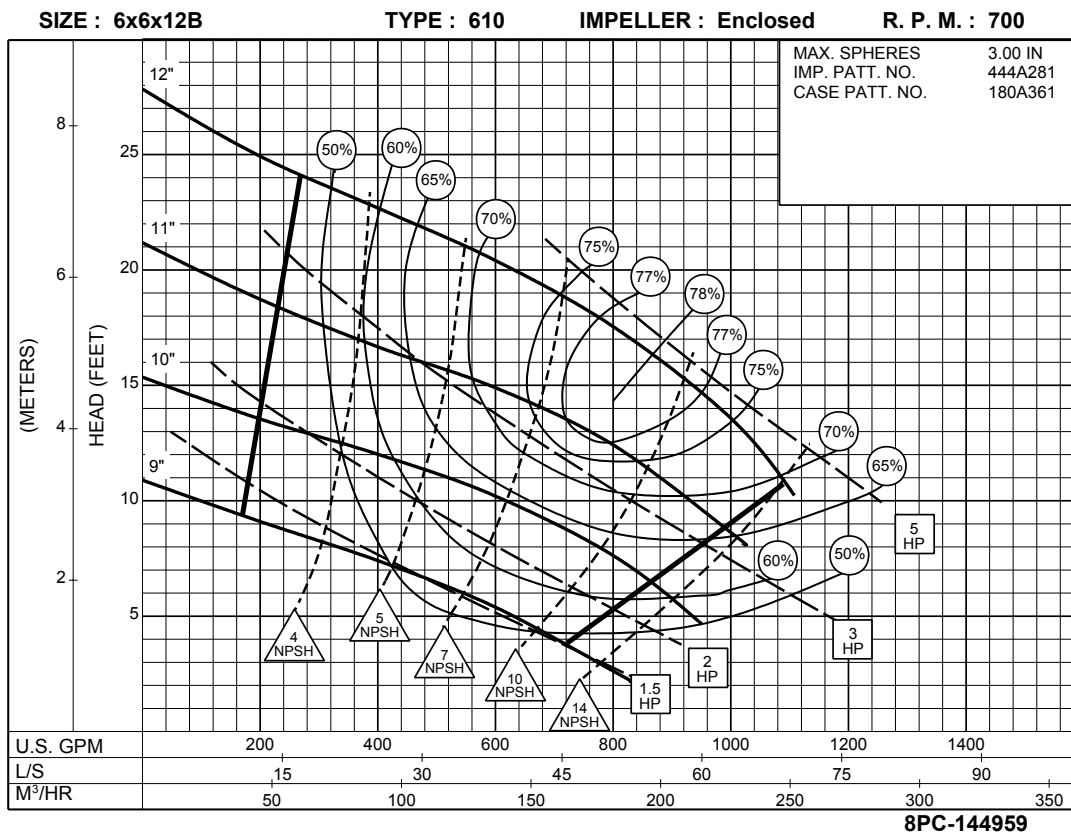
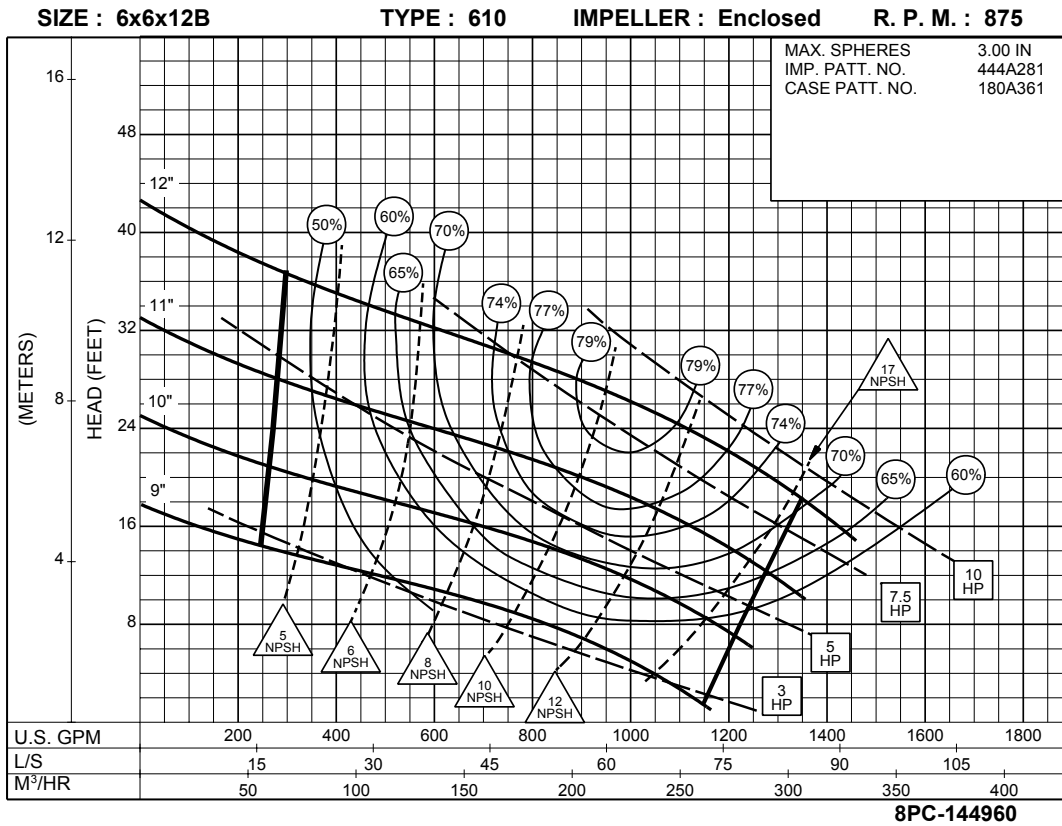

6 x 6 x 12
SERIES 610

ENCLOSED IMPELLER

SIZE : 6x6x12 TYPE : 610 IMPELLER : Enclosed R. P. M. : 875

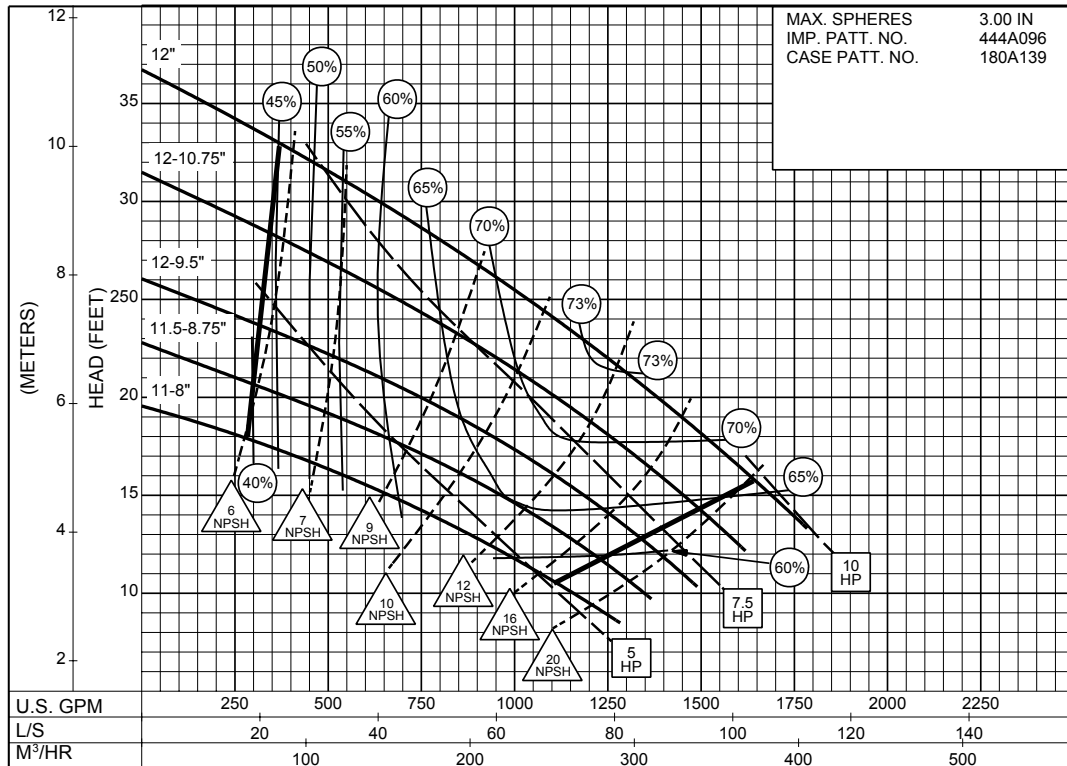

8PC-115573

875
RPM

SIZE : 6x6x12 TYPE : 610 IMPELLER : Enclosed R. P. M. : 700

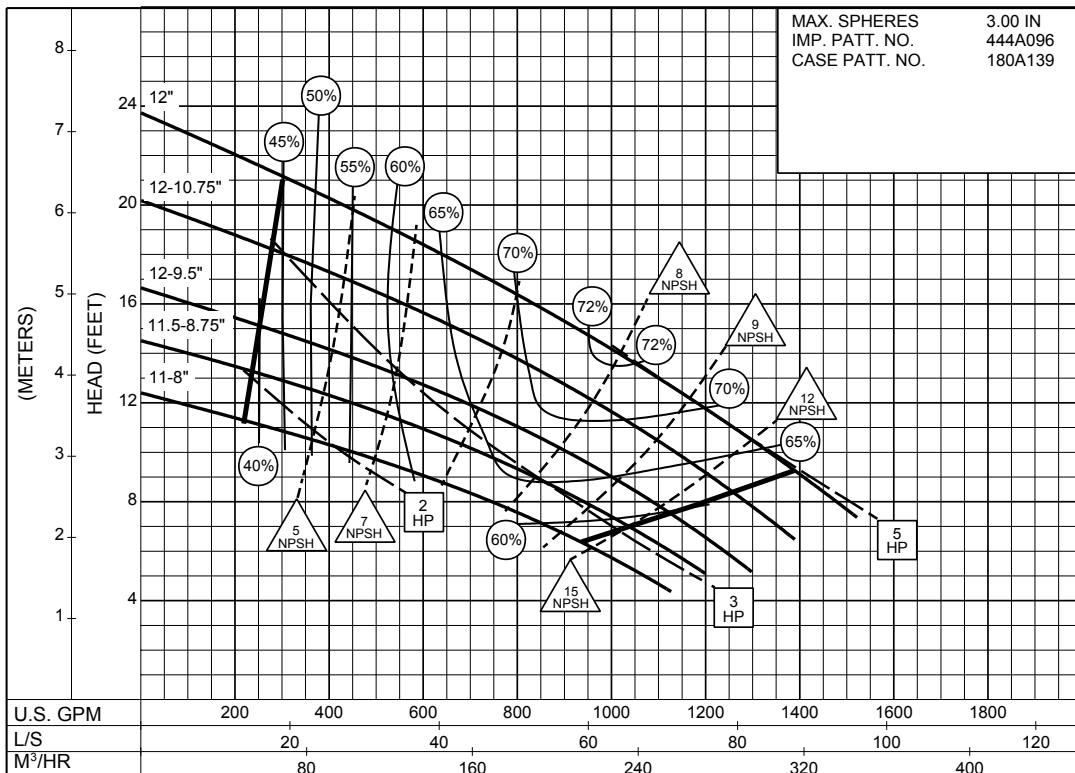

8PC-115574

700
RPM

6 x 8 x 15 SERIES 610

ENCLOSED IMPELLER

SIZE : 6x8x15 TYPE : 610 IMPELLER : Enclosed R. P. M. : 1750

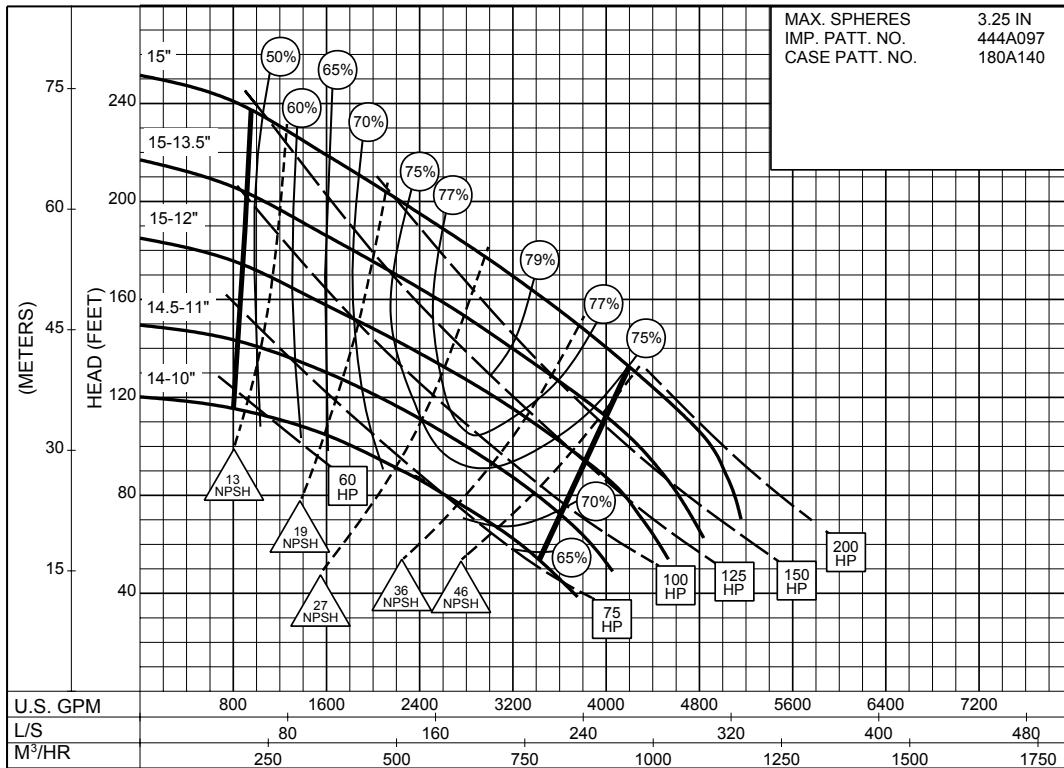

8PC-115575

1750
RPM

SIZE : 6x8x15 TYPE : 610 IMPELLER : Enclosed R. P. M. : 1150

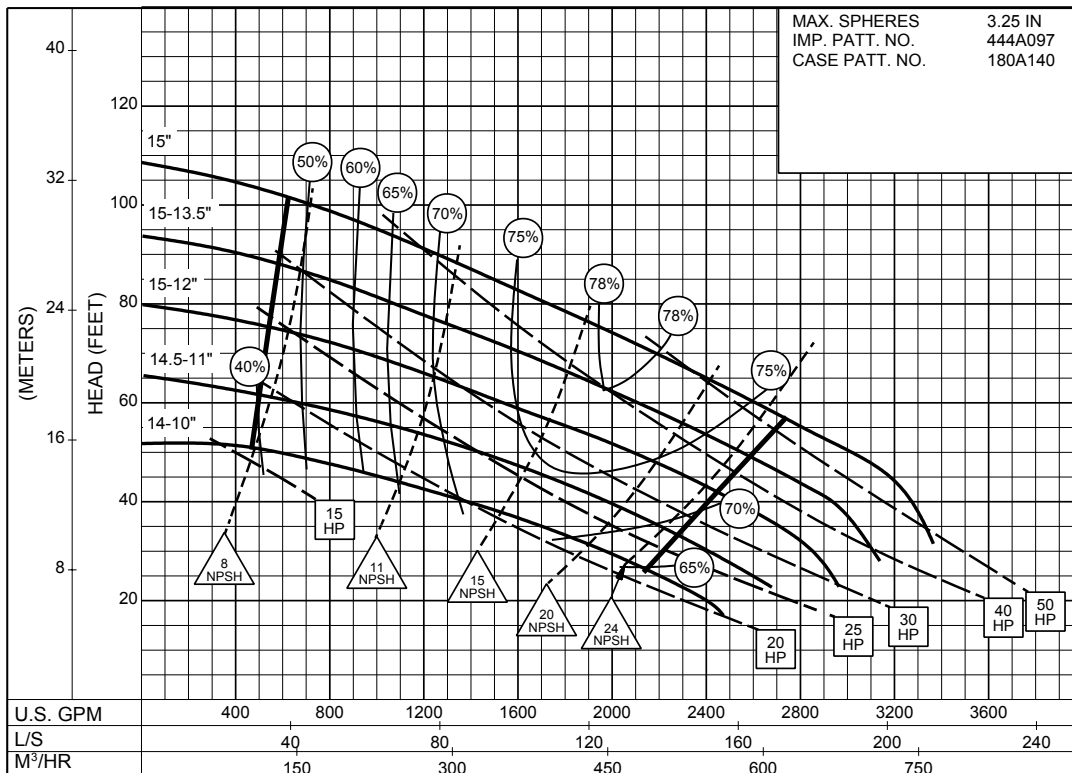

8PC-115576

1150
RPM

6 x 8 x 15
SERIES 610

ENCLOSED IMPELLER

SIZE : 6x8x15 TYPE : 610 IMPELLER : Enclosed R. P. M. : 875

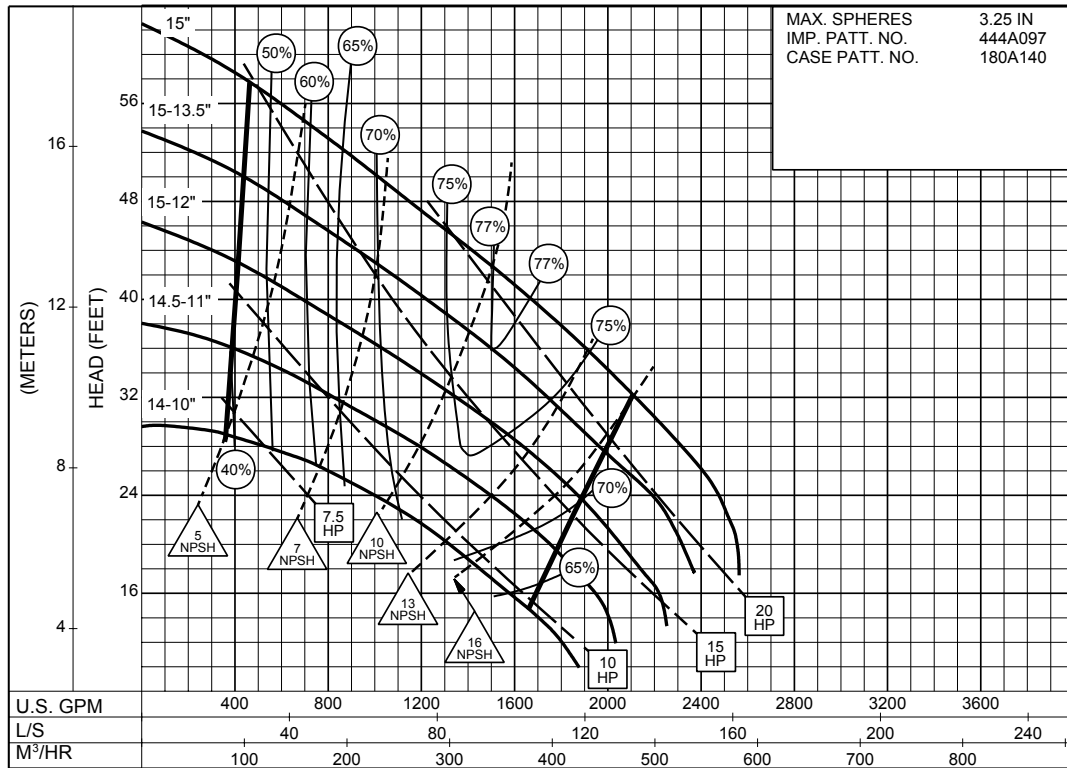

8PC-115577

875
RPM

SIZE : 6x8x15 TYPE : 610 IMPELLER : Enclosed R. P. M. : 700

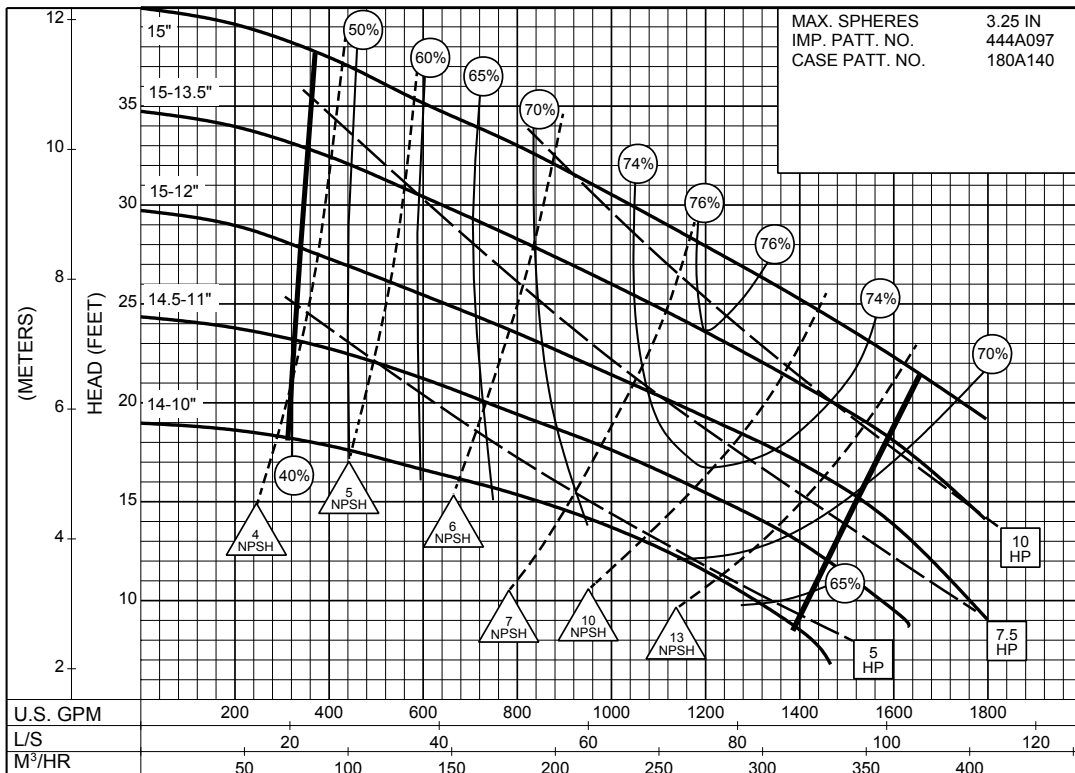

8PC-115578

700
RPM

6 x 8 x 15 SERIES 610

ENCLOSED IMPELLER

SIZE : 6x8x15

TYPE : 610

IMPELLER : Enclosed

R. P. M. : 580

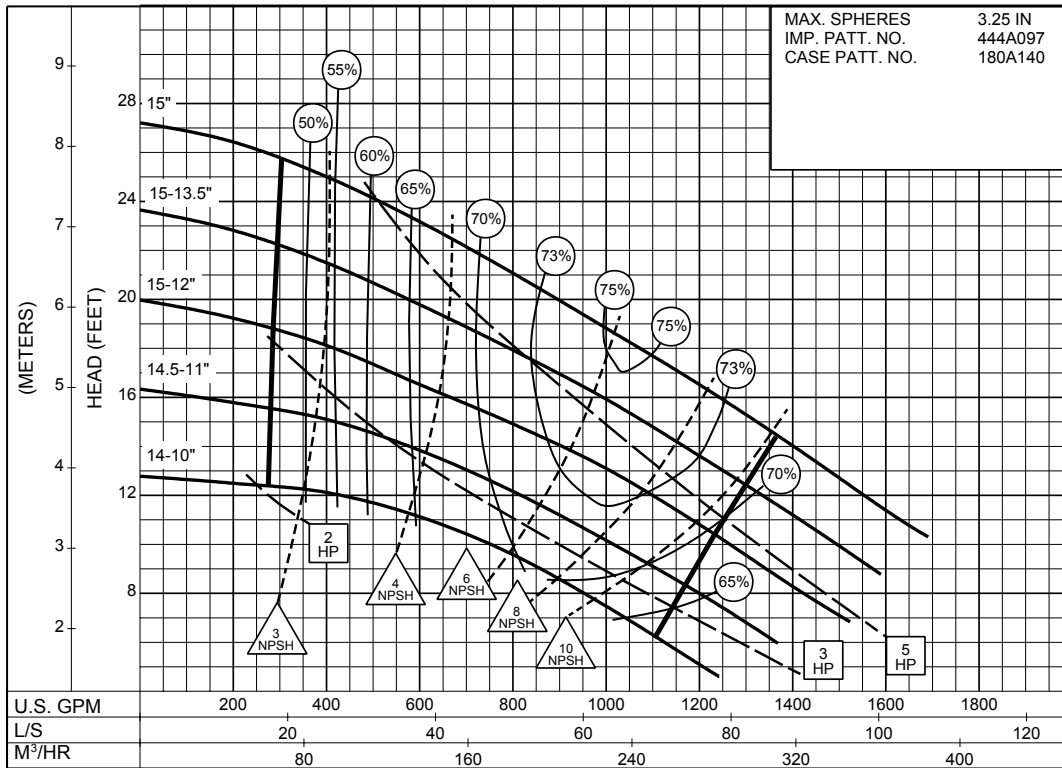

580
RPM

8PC-115579

6 x 8 x 18
SERIES 610

ENCLOSED IMPELLER

SIZE : 6x8x18 TYPE : 610 IMPELLER : Enclosed R. P. M. : 1150

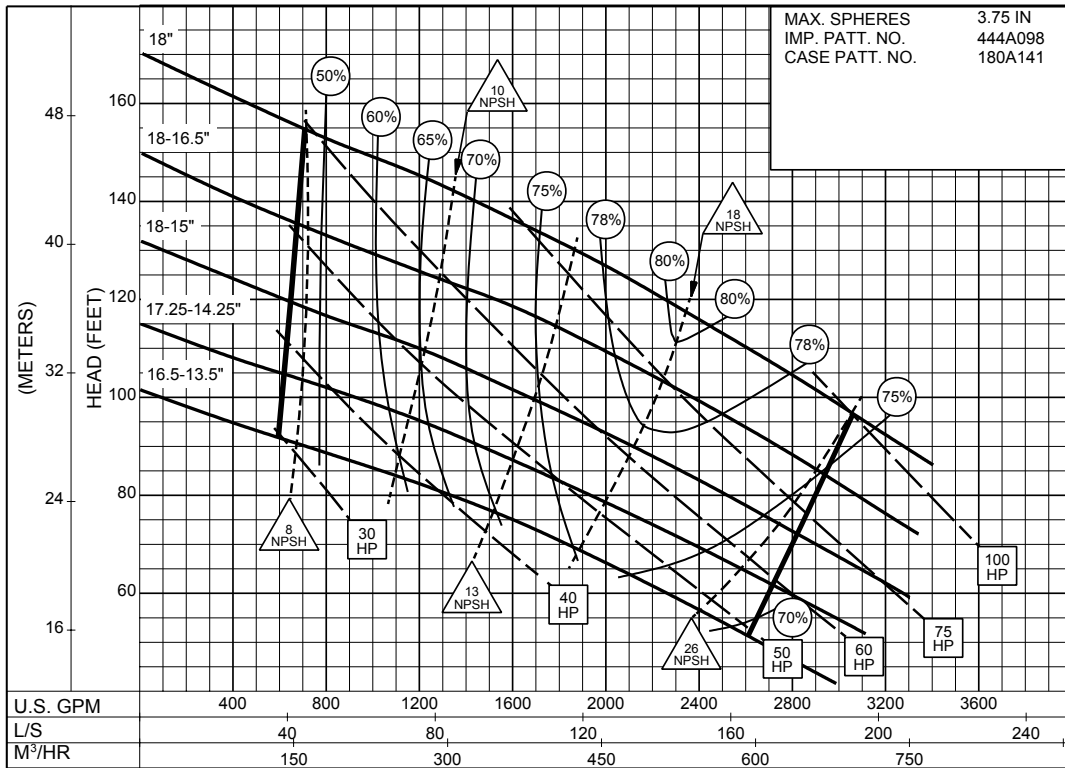

1150
RPM

8PC-115580

SIZE : 6x8x18 TYPE : 610 IMPELLER : Enclosed R. P. M. : 875

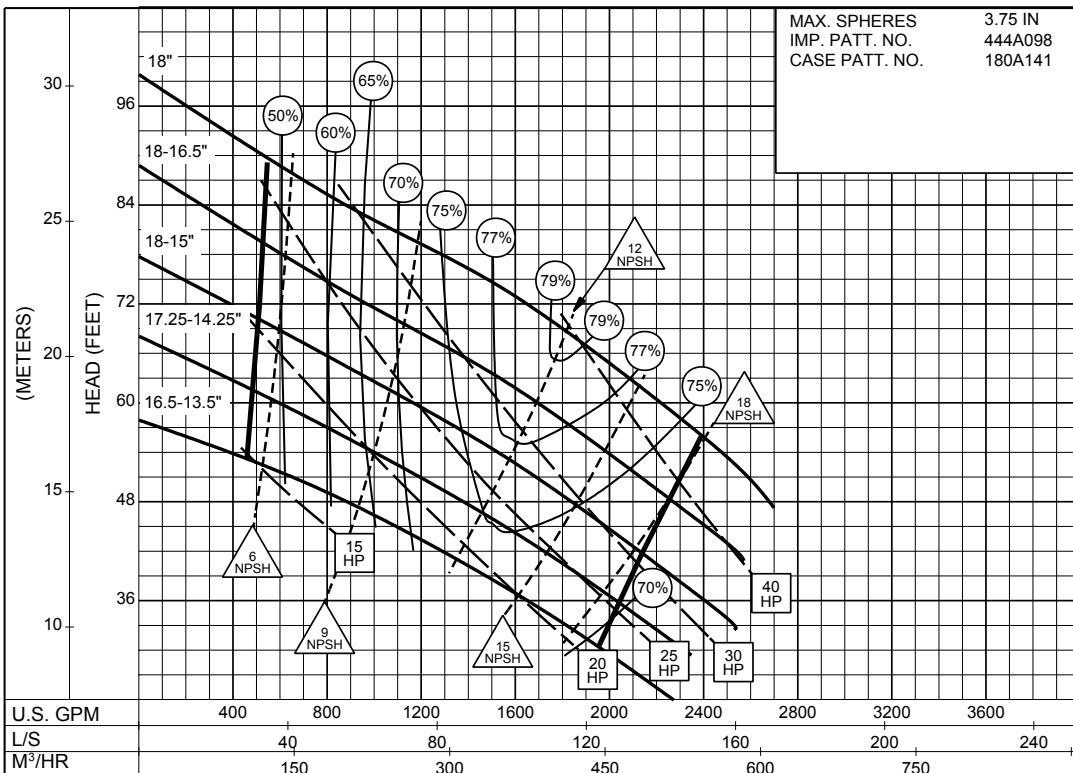

875
RPM

8PC-115581

6 x 8 x 18 SERIES 610

ENCLOSED IMPELLER

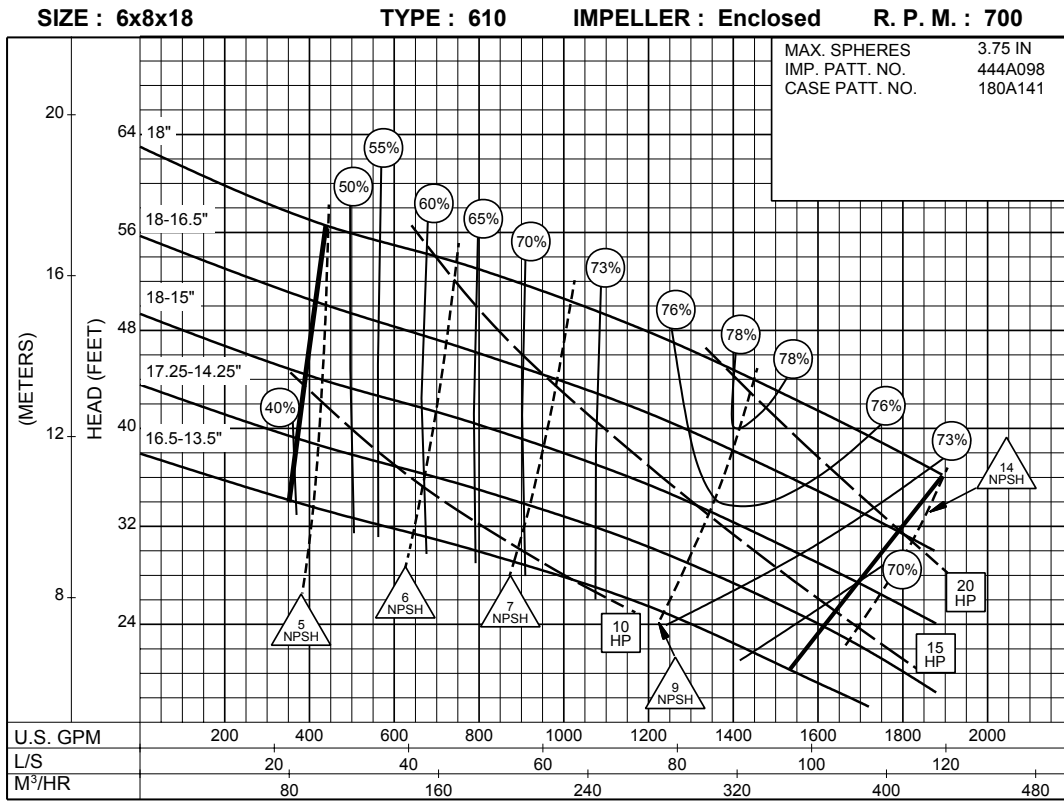

8PC-115582

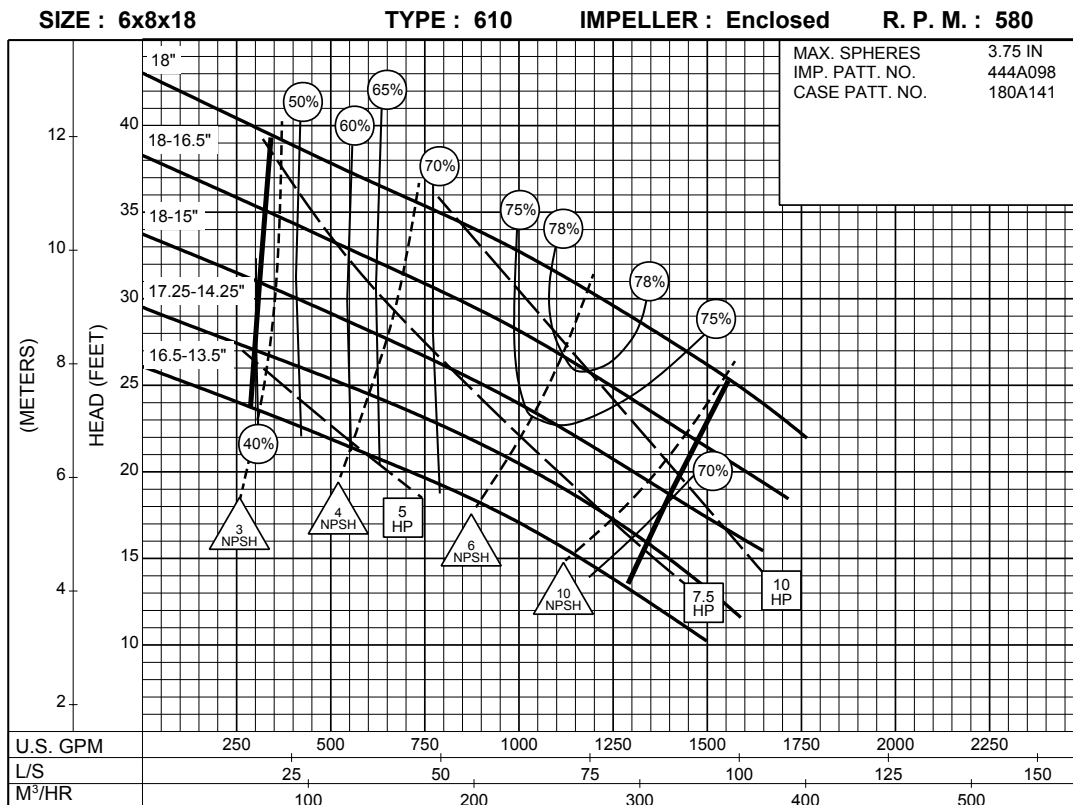

8PC-115583

8 x 8 x 15A
SERIES 610

ENCLOSED IMPELLER

SIZE : 8x8x15A TYPE : 610 IMPELLER : Enclosed R. P. M. : 1150

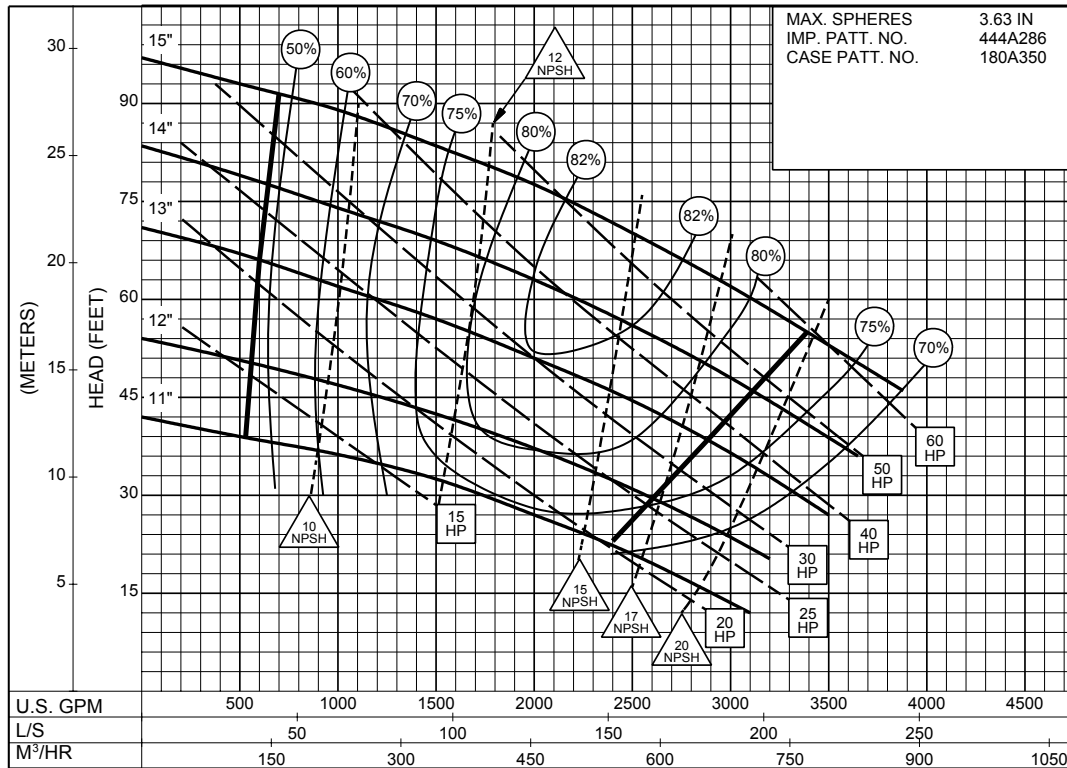

1150
RPM

8PC-142576

SIZE : 8x8x15A TYPE : 610 IMPELLER : Enclosed R. P. M. : 875

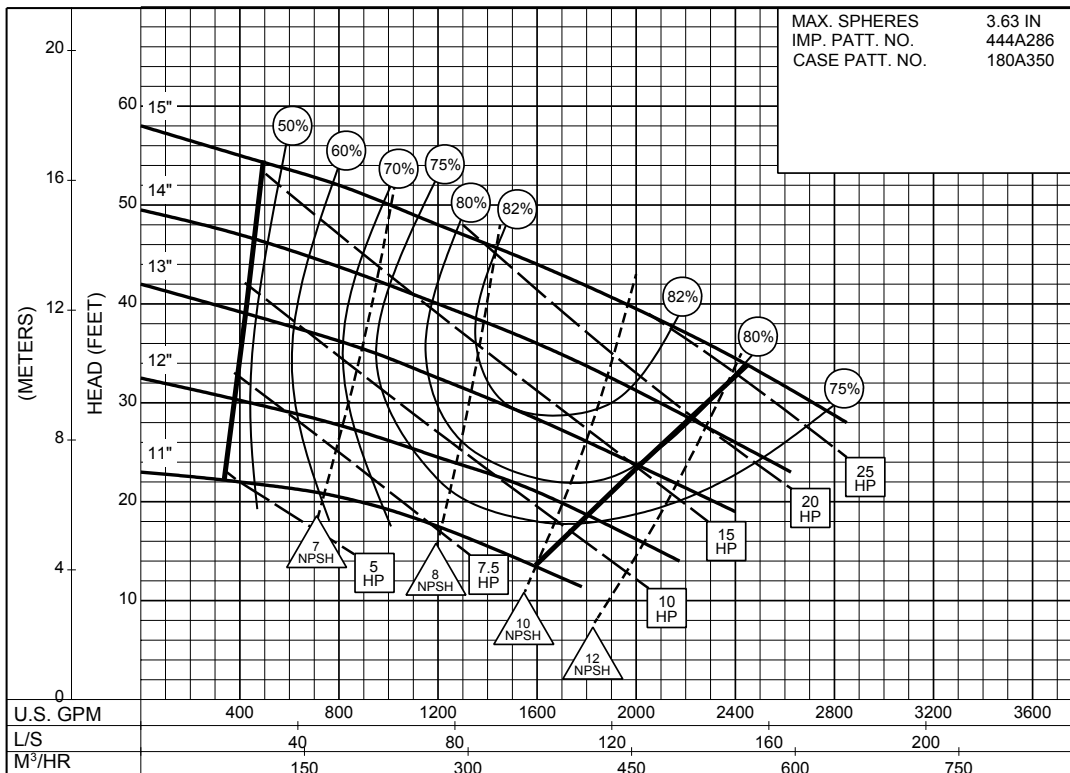

875
RPM

8PC-142577

8 x 8 x 15A SERIES 610

ENCLOSED IMPELLER

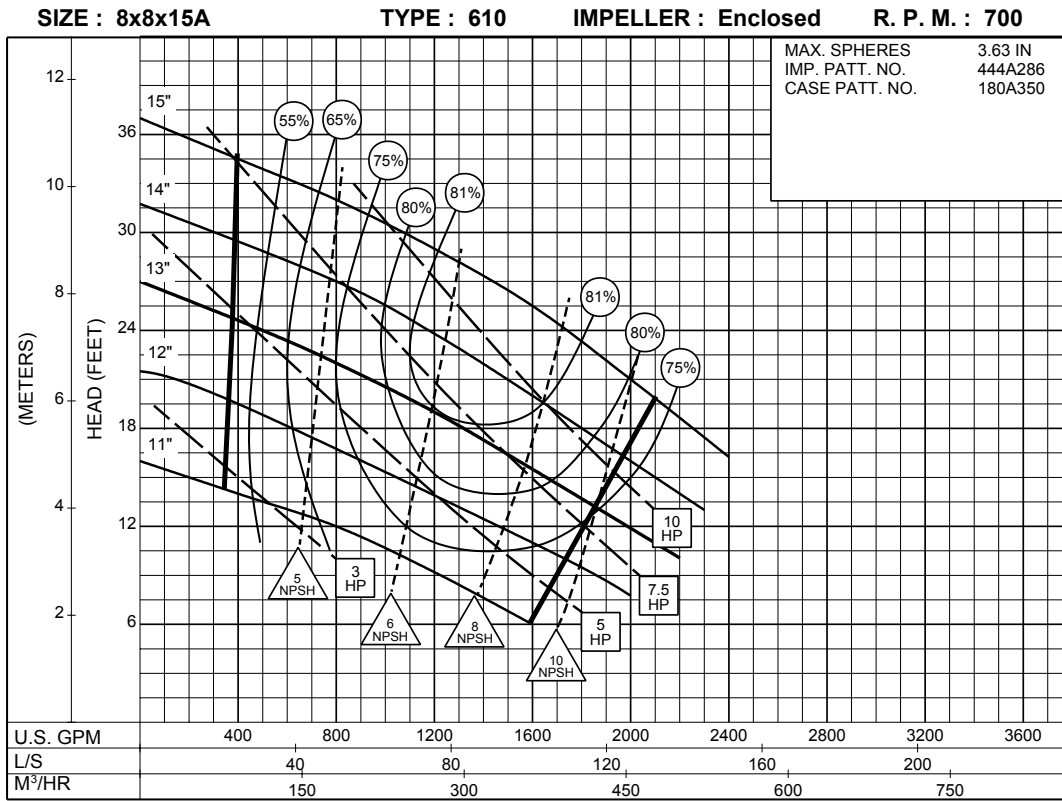

8PC-142578

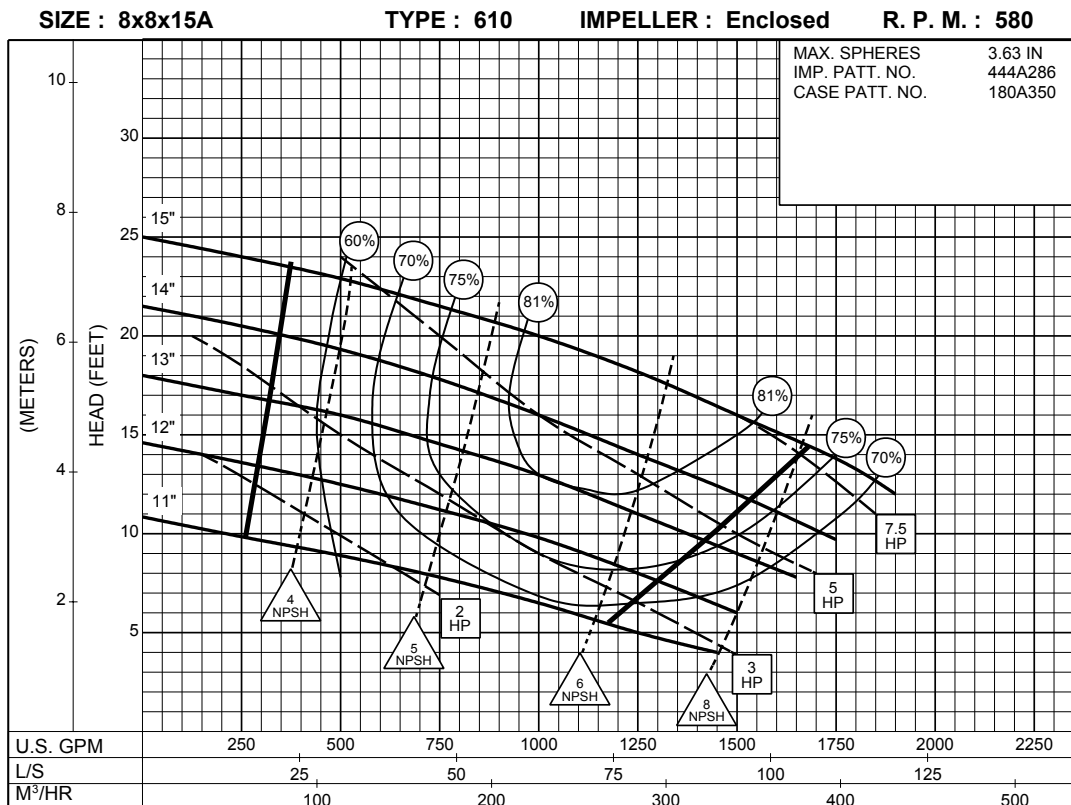

8PC-142579



SIZE : 8x10x18 TYPE : 610 IMPELLER : Enclosed R. P. M. : 1150

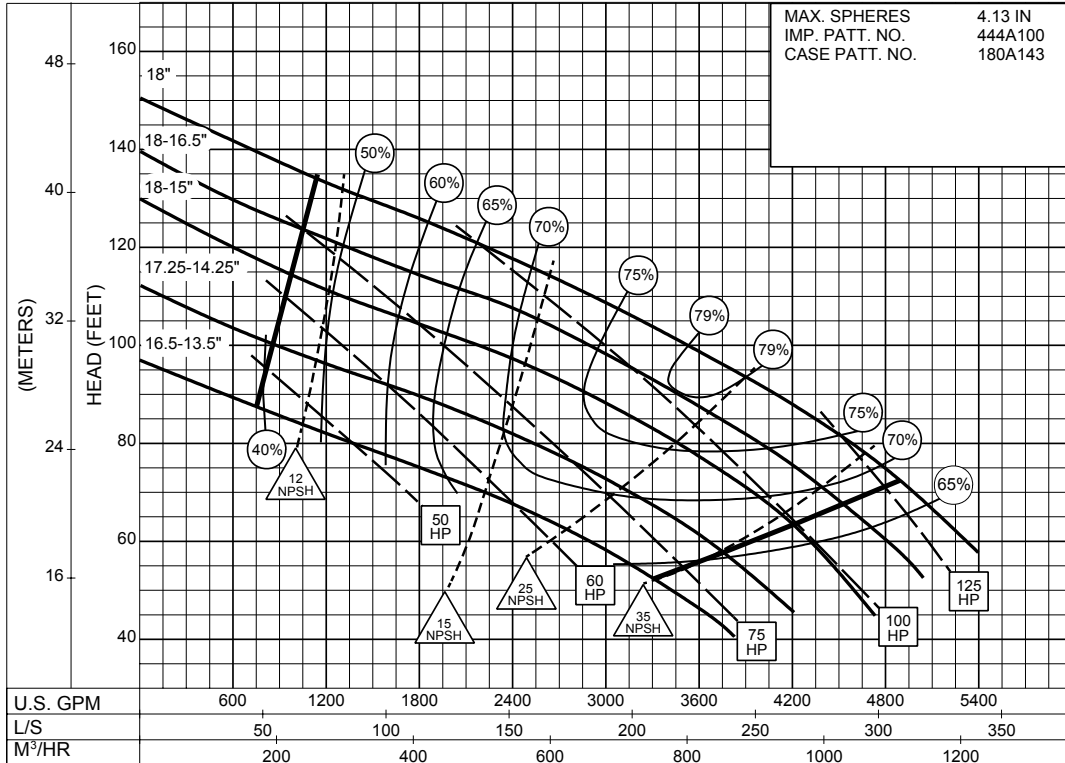

MAX. SPHERES 4.13 IN
 IMP. PATT. NO. 444A100
 CASE PATT. NO. 180A143

1150 RPM

8PC-115588

SIZE : 8x10x18 TYPE : 610 IMPELLER : Enclosed R. P. M. : 875

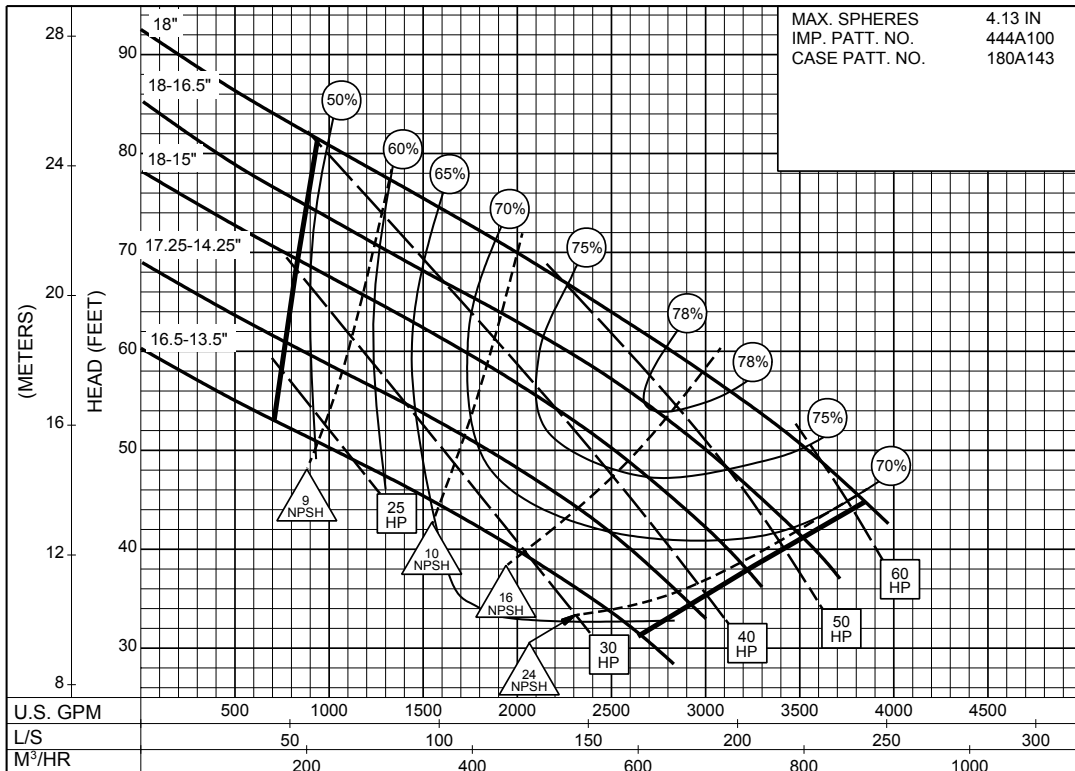

MAX. SPHERES 4.13 IN
 IMP. PATT. NO. 444A100
 CASE PATT. NO. 180A143

875 RPM

8PC-115589

8 x 10 x 18 SERIES 610

ENCLOSED IMPELLER

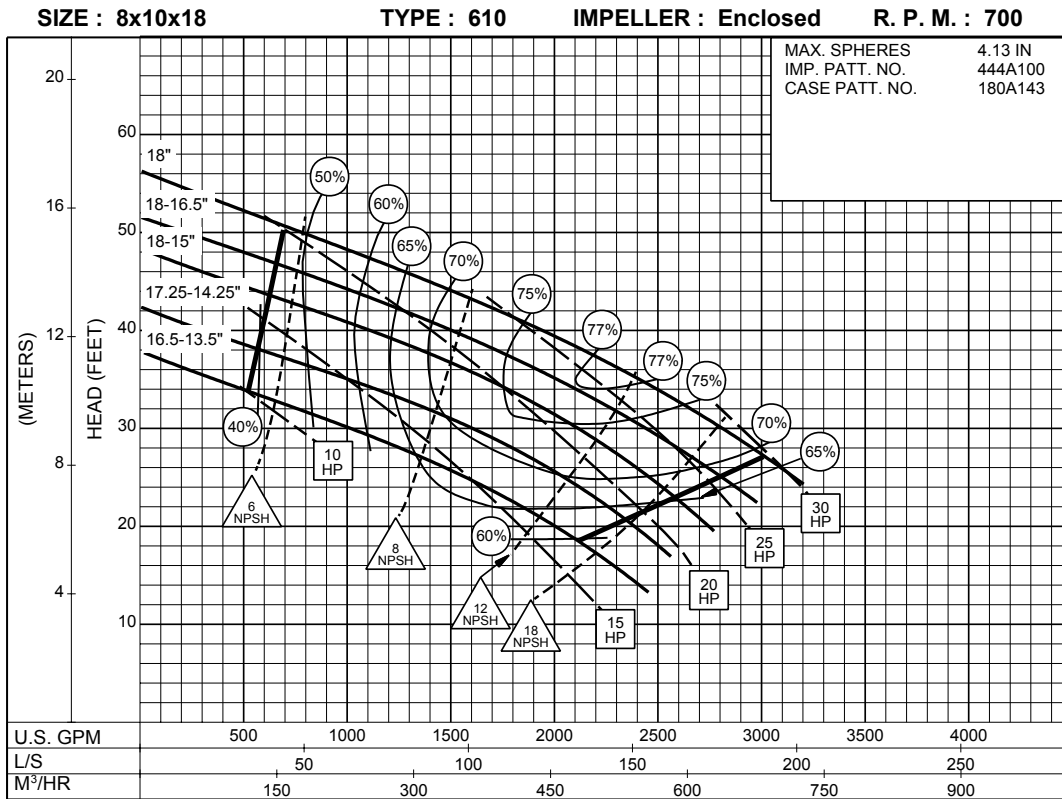

8PC-115590

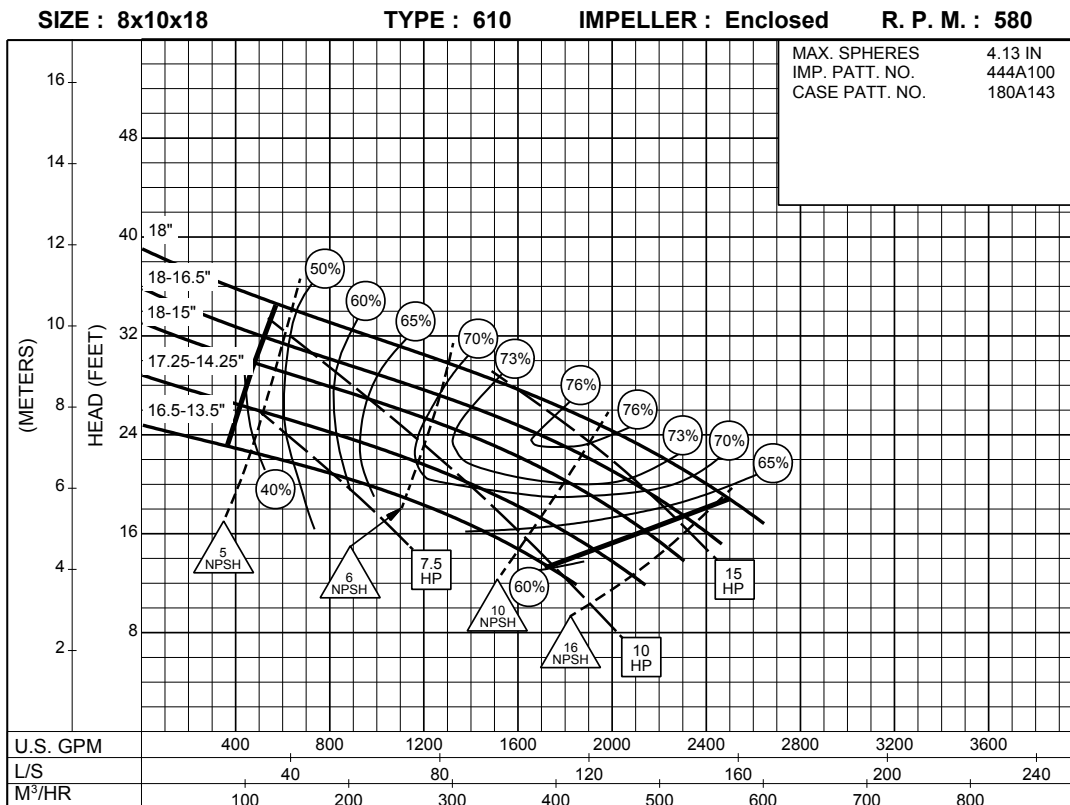

8PC-115591

8 x 10 x 22 SERIES 610

ENCLOSED IMPELLER

SIZE : 8x10x22 TYPE : 610 IMPELLER : Enclosed R. P. M. : 875

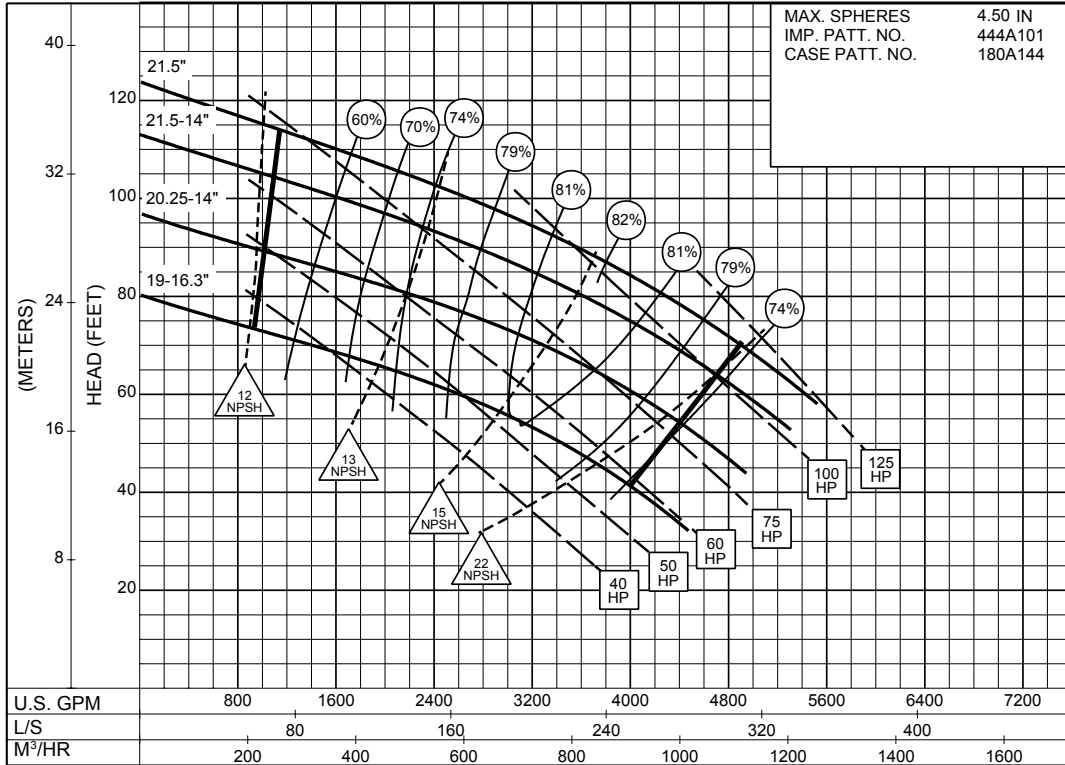

8PC-115592B

875
RPM

SIZE : 8x10x22 TYPE : 610 IMPELLER : Enclosed R. P. M. : 700

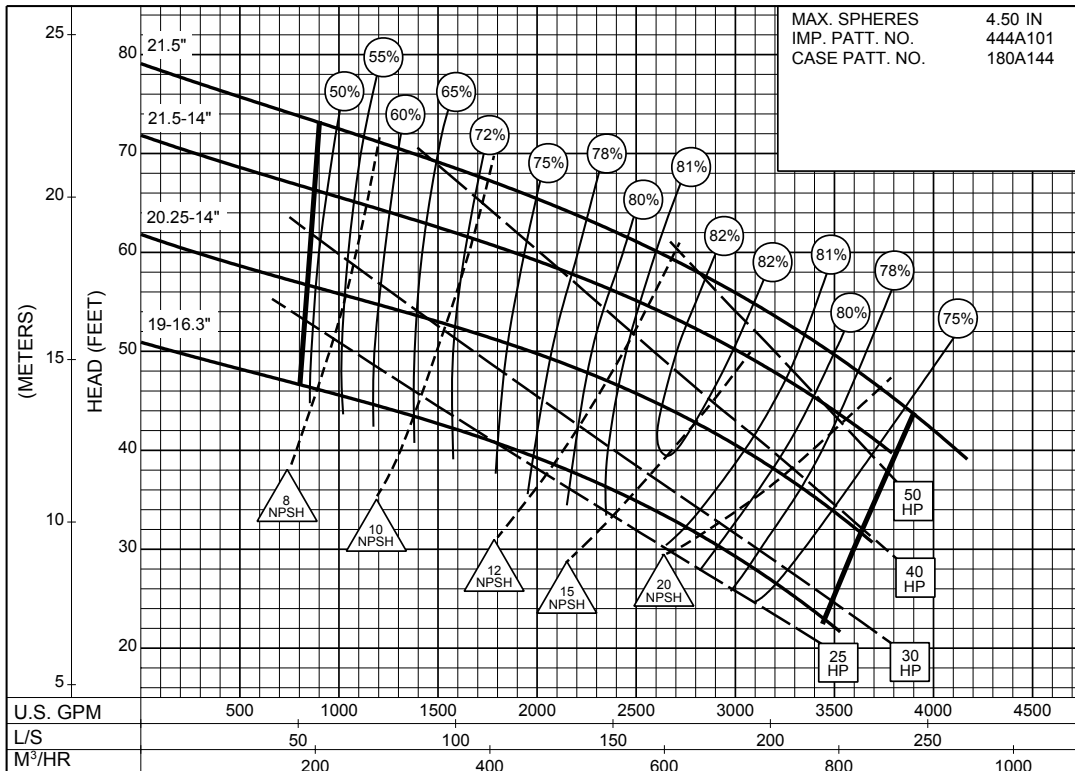

8PC-115593A

700
RPM

8 x 10 x 22 SERIES 610

ENCLOSED IMPELLER

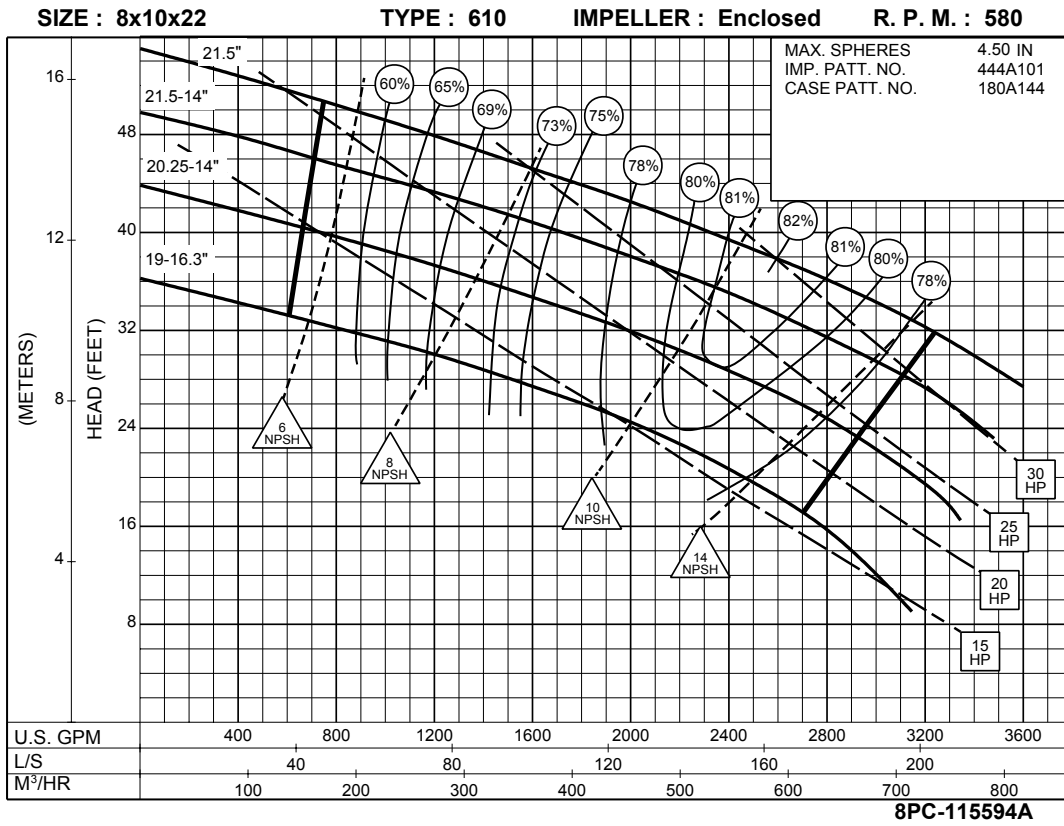

SIZE : 10x10x15 TYPE : 610 IMPELLER : Enclosed R. P. M. : 1150

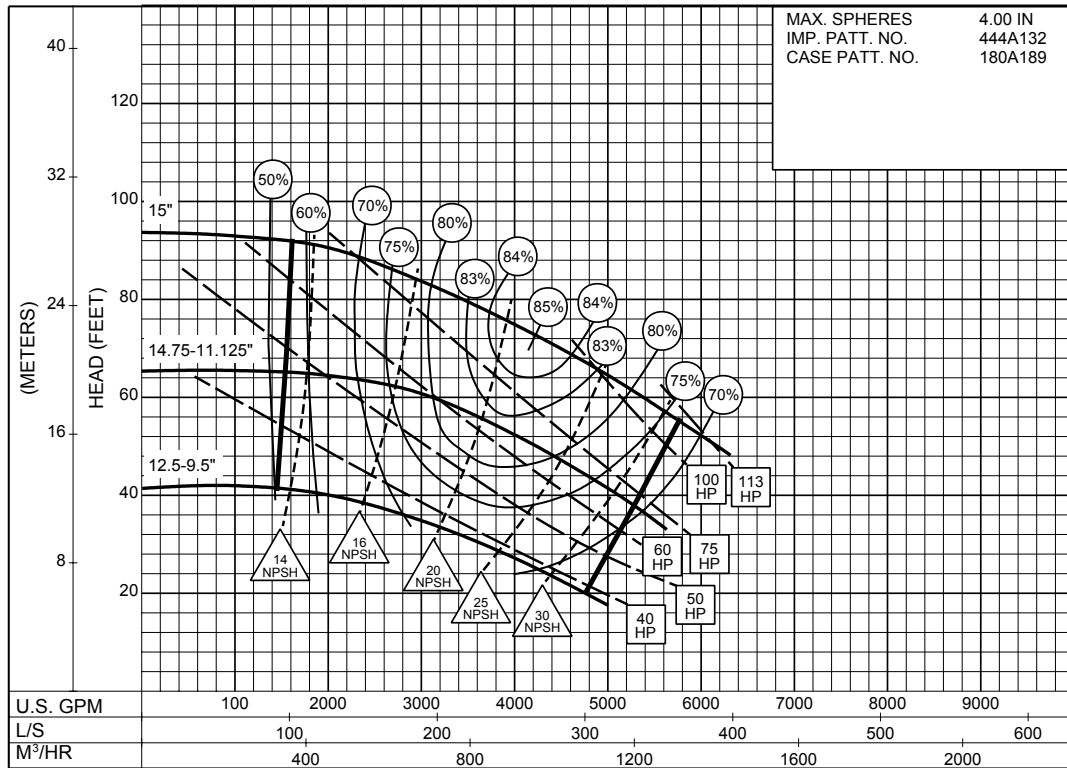

1150
RPM

8PC-126742

SIZE : 10x10x15 TYPE : 610 IMPELLER : Enclosed R. P. M. : 875

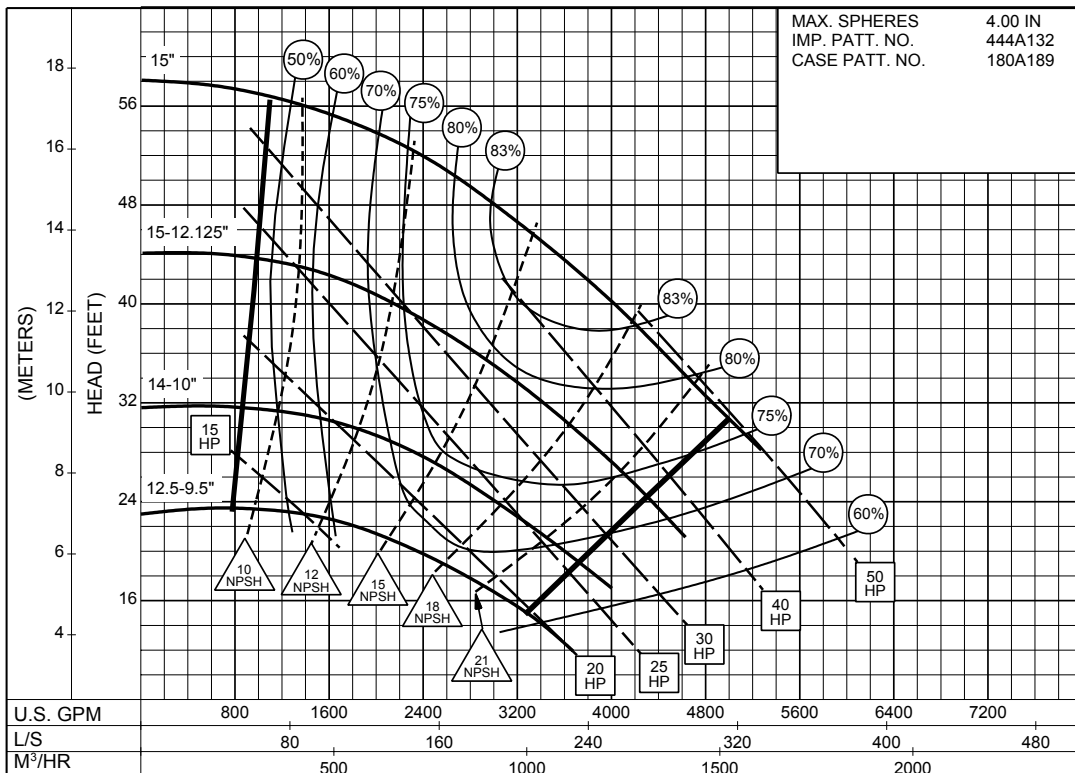

875
RPM

8PC-116809

10 x 10 x 15 SERIES 610

ENCLOSED IMPELLER

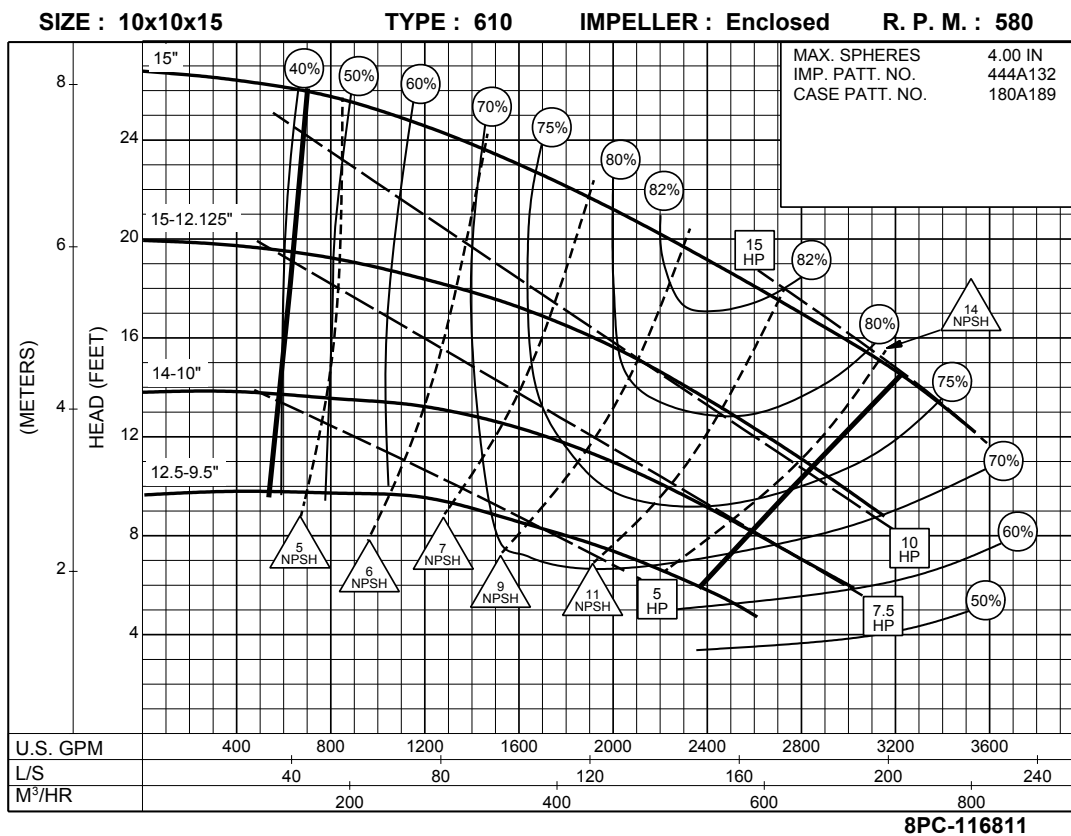
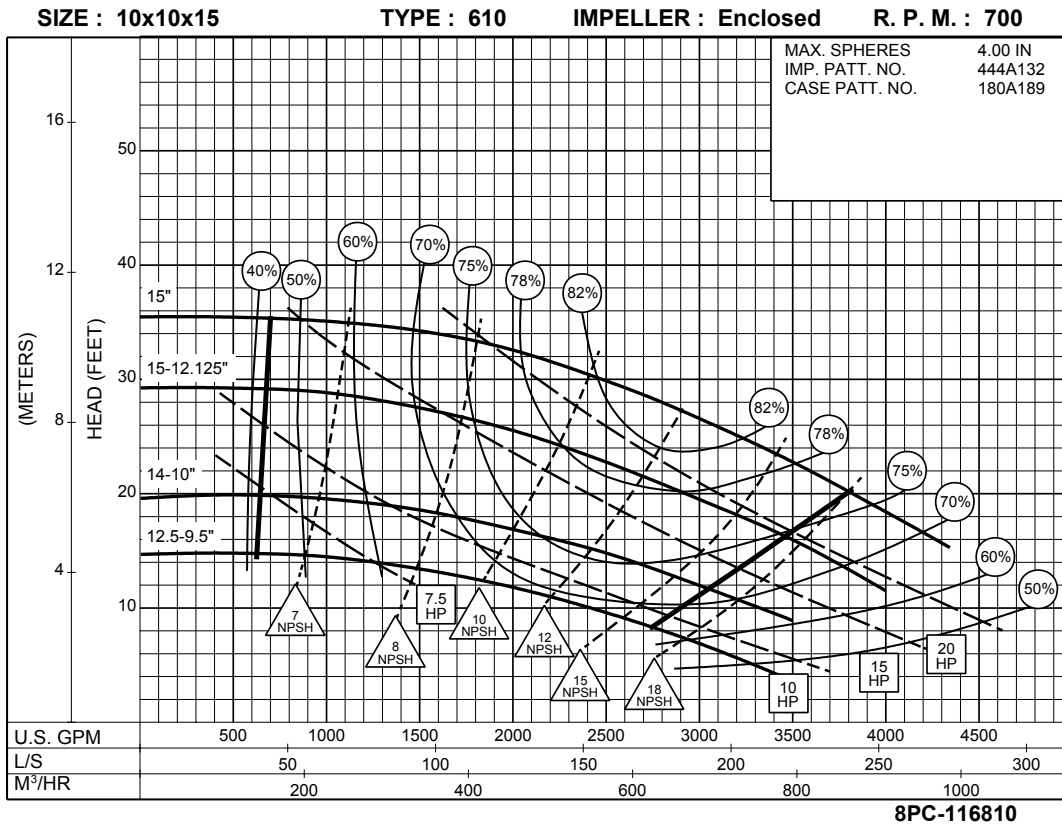

SIZE : 10x10x22

TYPE : 610

IMPELLER : Enclosed

R. P. M. : 1175

MAX. SPHERES 5.63 IN
IMP. PATT. NO. 444A101
CASE PATT. NO. 180A269

1175
RPM

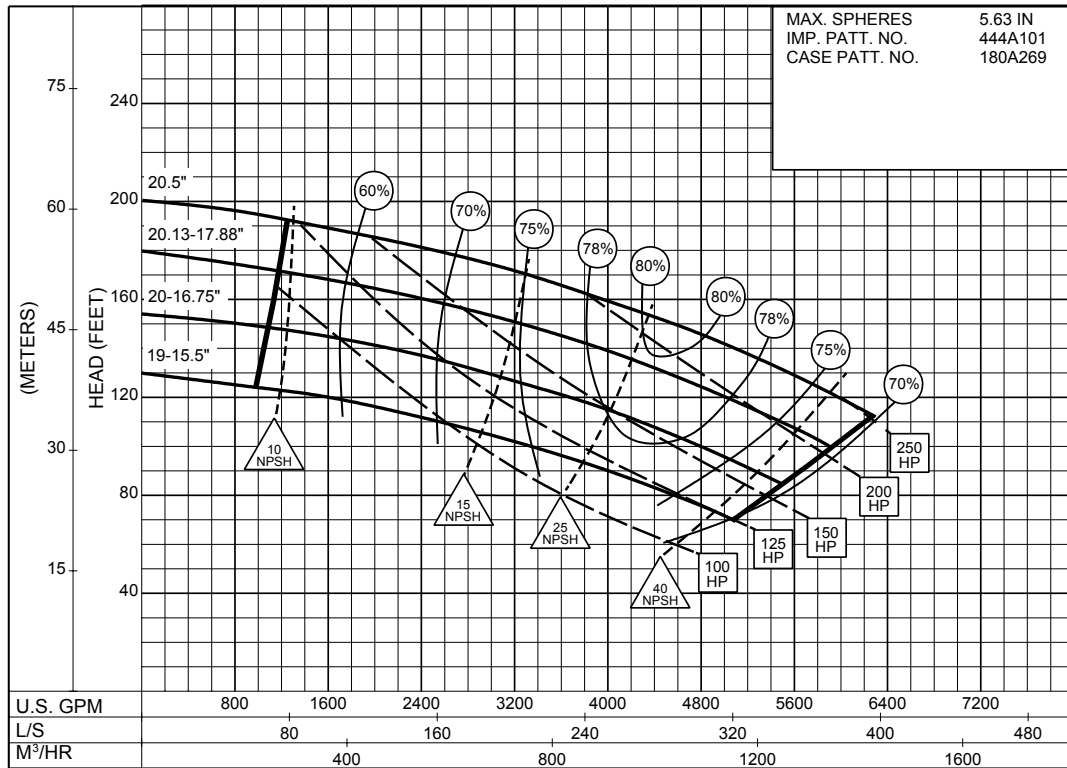

8PC-134351

10 x 12 x 22 SERIES 610

ENCLOSED IMPELLER

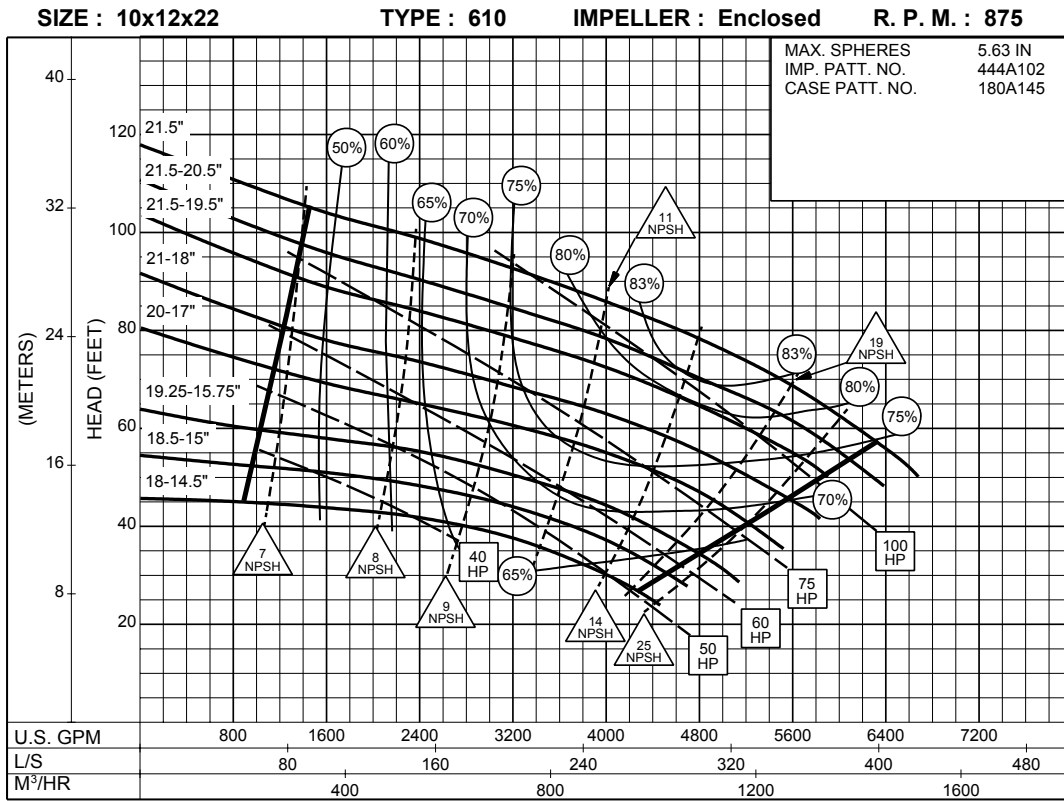

**875
RPM**

8PC-115595

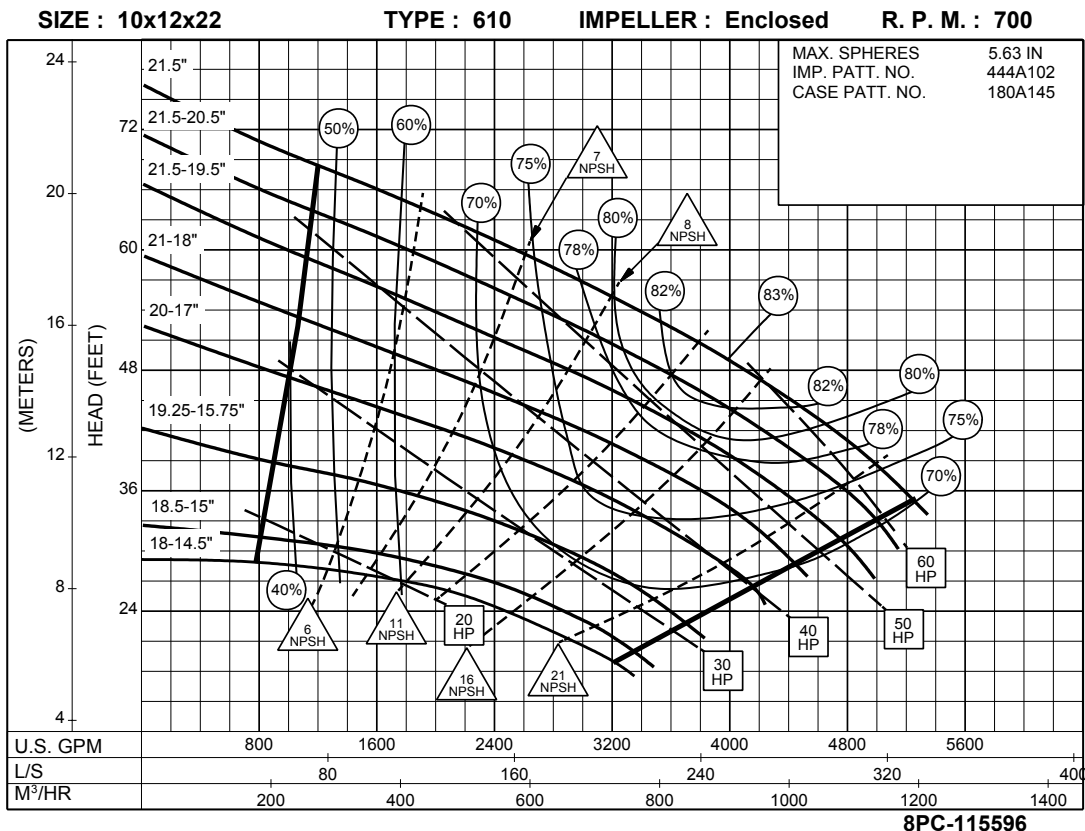

**700
RPM**

8PC-115596

SIZE : 10x12x22

TYPE : 610

IMPELLER : Enclosed

R. P. M. : 580

MAX. SPHERES 5.63 IN
 IMP. PATT. NO. 444A102
 CASE PATT. NO. 180A145

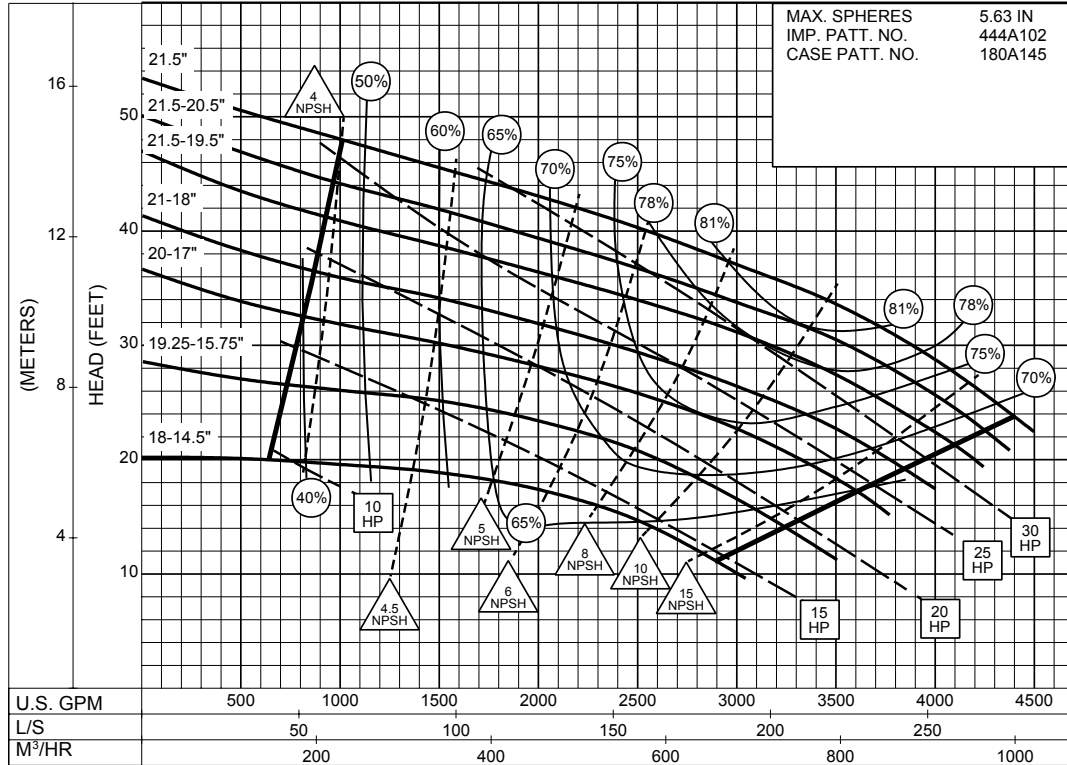

580
RPM

8PC-115597

12 x 12 x 22 SERIES 610

ENCLOSED IMPELLER

SIZE : 12x12x22

TYPE : 610

IMPELLER : Enclosed

R. P. M. : 1175

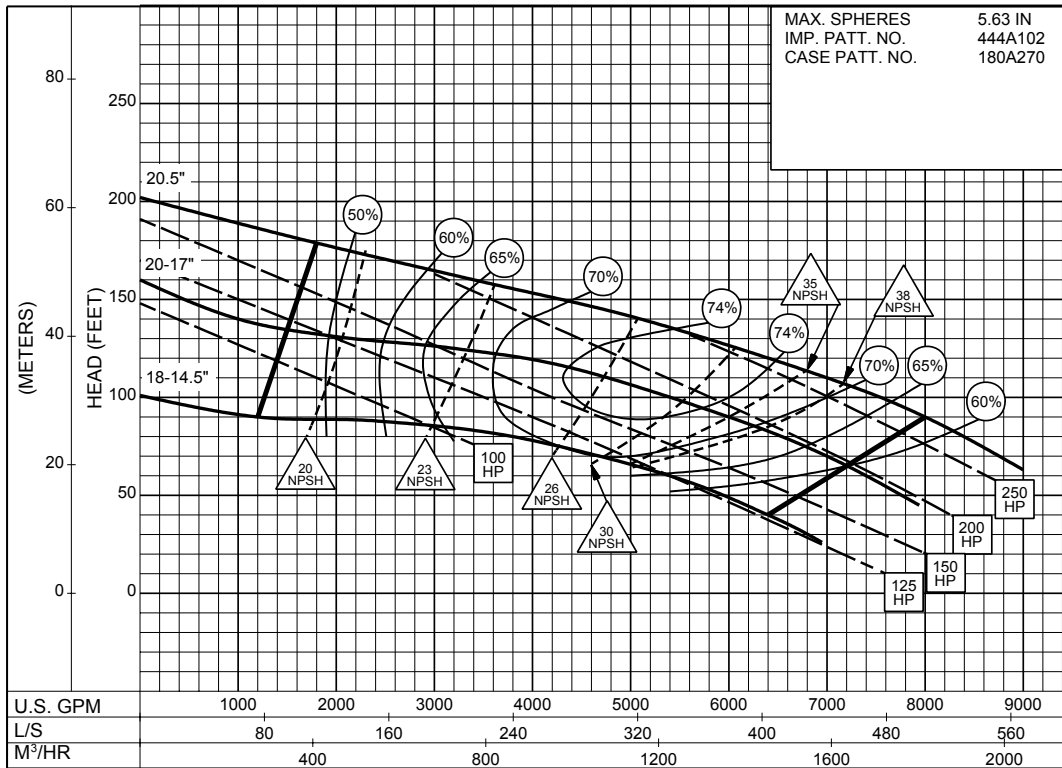

1175
RPM

PC-154530

SIZE : 12x14x22A TYPE : 610 IMPELLER : Enclosed R. P. M. : 875

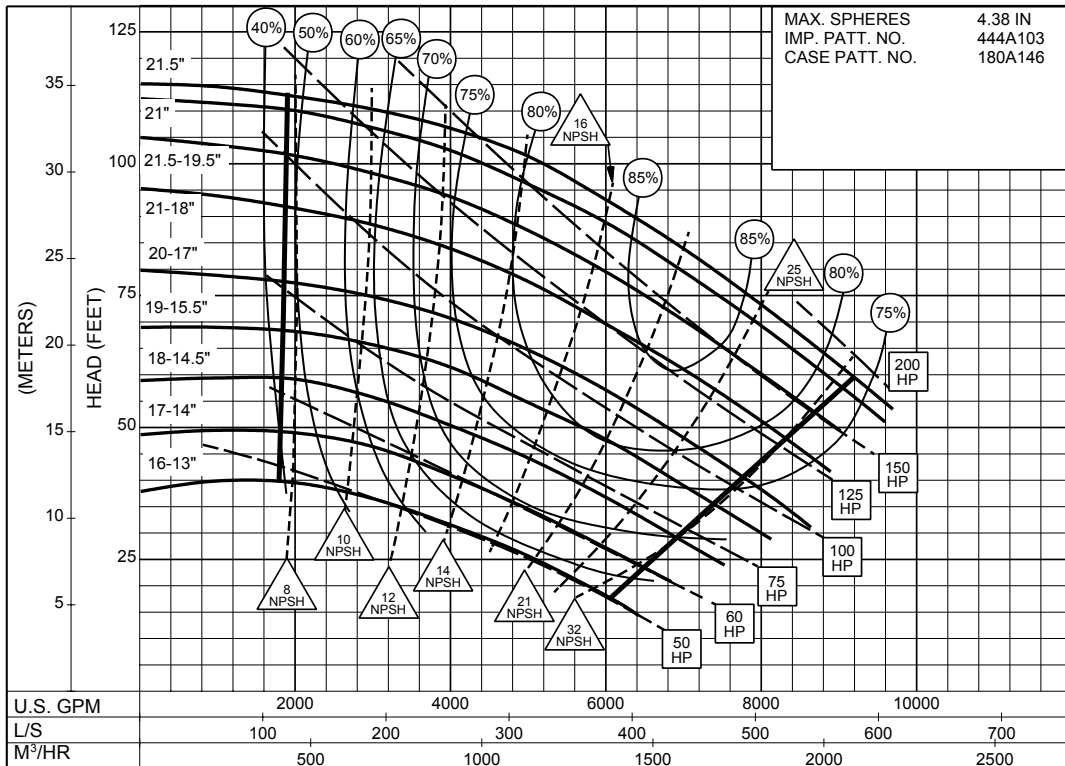

8PC-126830

875
RPM

SIZE : 12x14x22A TYPE : 610 IMPELLER : Enclosed R. P. M. : 700

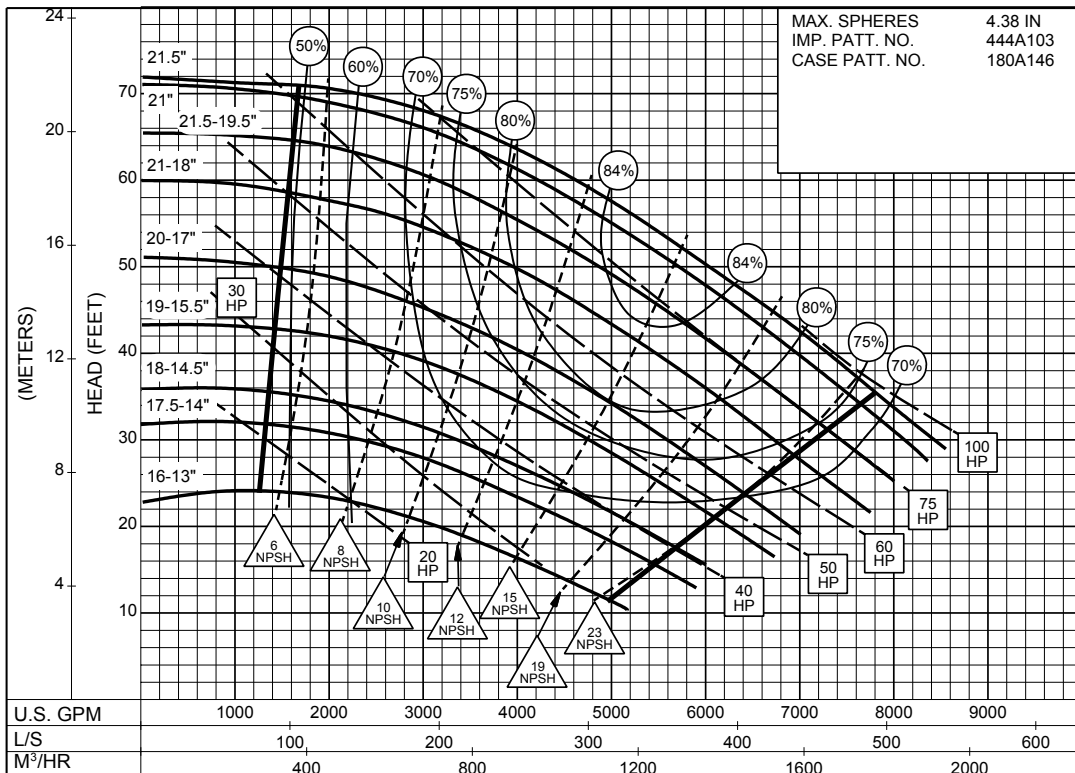

8PC-126831

700
RPM

12 x 14 x 22A SERIES 610

ENCLOSED IMPELLER

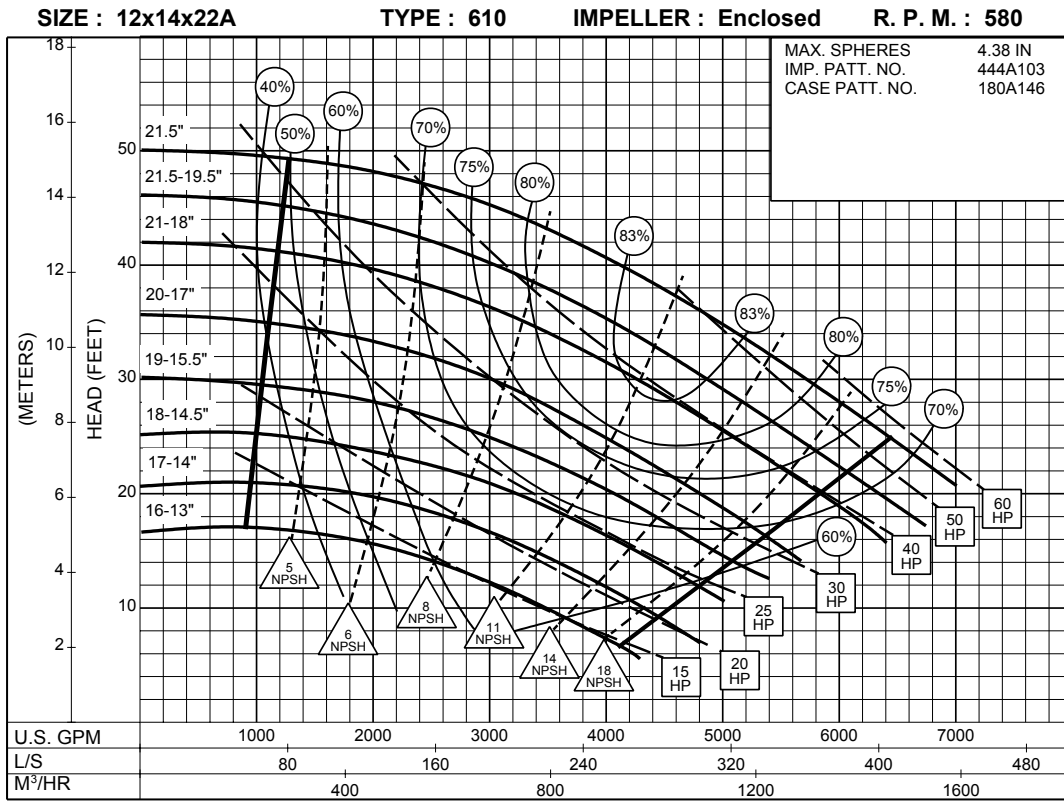

SIZE : 12x14x22B TYPE : 610 IMPELLER : Enclosed R. P. M. : 875

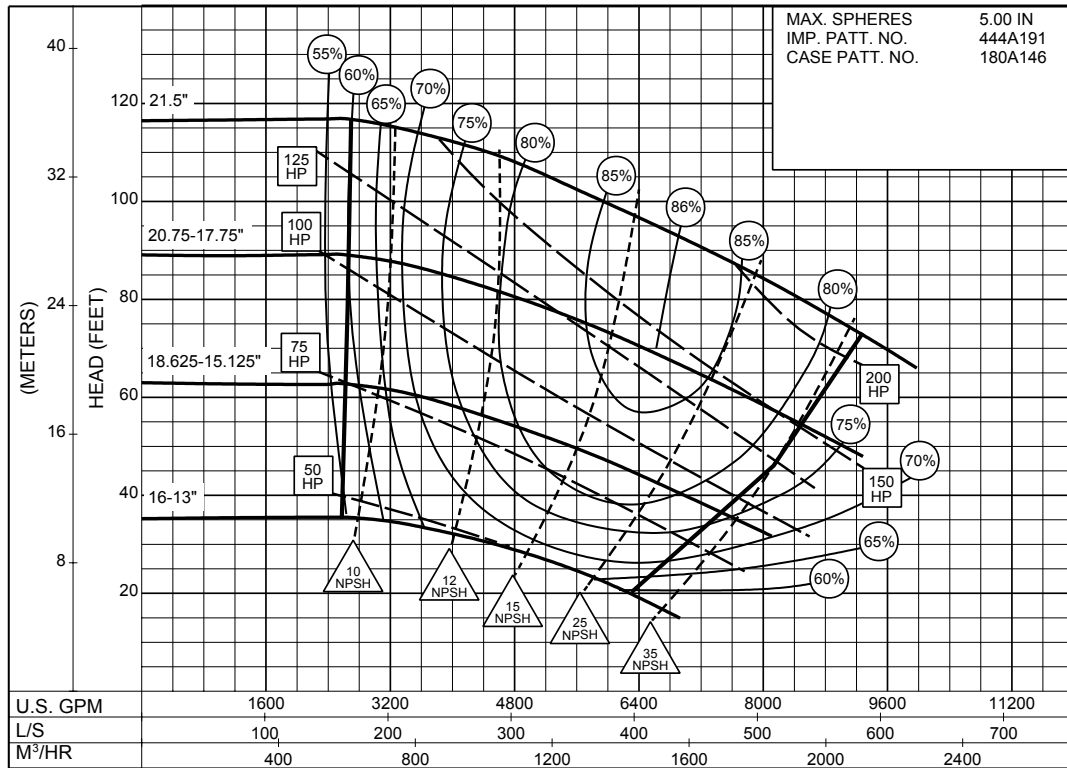

8PC-132458

875
RPM

SIZE : 12x14x22B TYPE : 610 IMPELLER : Enclosed R. P. M. : 700

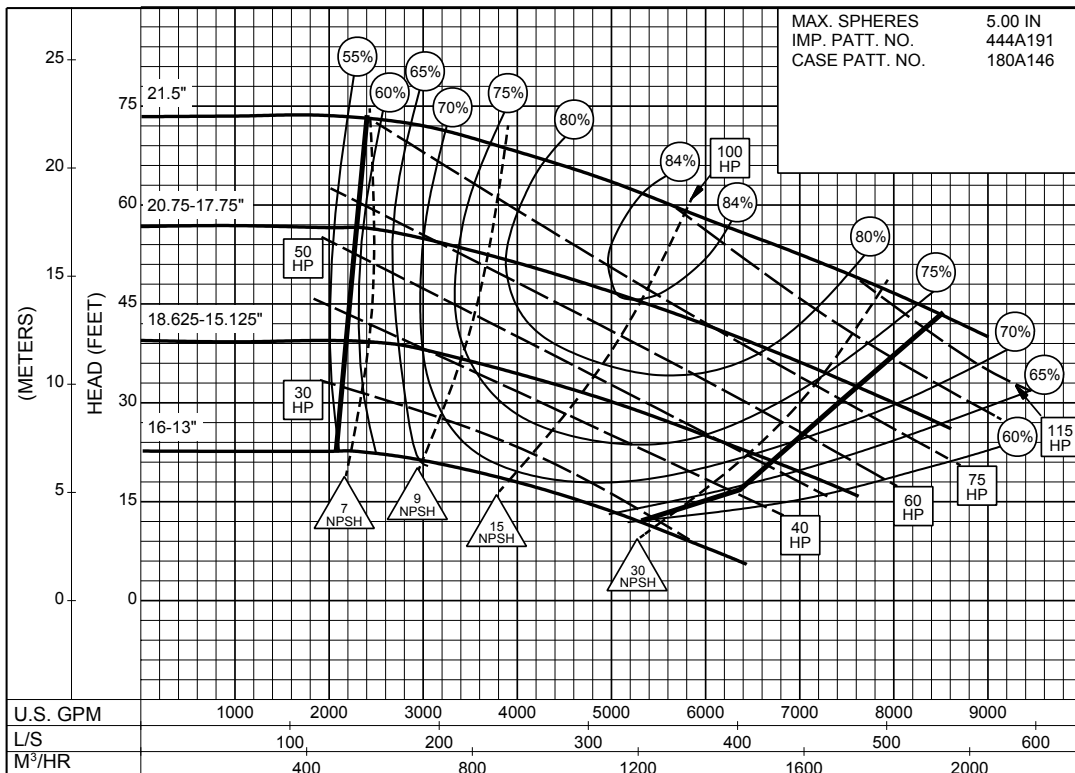

8PC-132459

700
RPM

12 x 14 x 22B SERIES 610

ENCLOSED IMPELLER

SIZE : 12x14x22B TYPE : 610 IMPELLER : Enclosed R. P. M. : 580

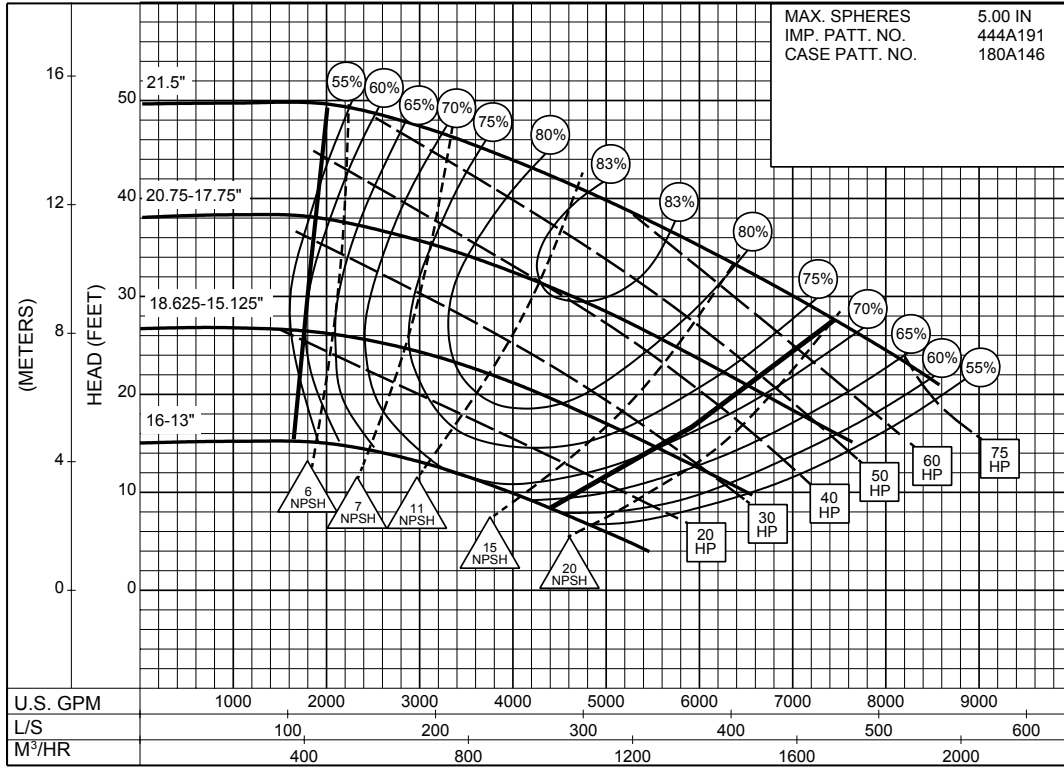

580
RPM

8PC-132460

14 x 14 x 22A SERIES 610

ENCLOSED IMPELLER

SIZE : 14x14x22A TYPE : 610 IMPELLER : Enclosed R. P. M. : 1175

MAX. SPHERES 4.38 IN
IMP. PATT. NO. 444A103
CASE PATT. NO. 180A271

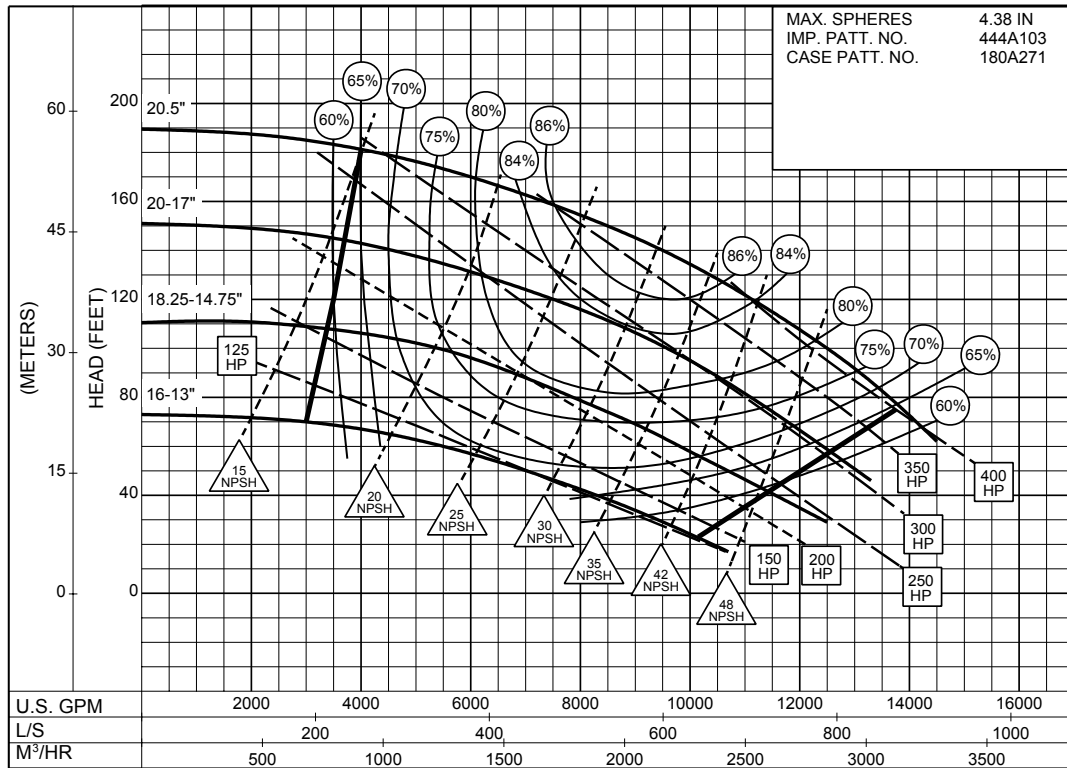

1175
RPM

PC-150828

16 x 16 x 20 SERIES 610

ENCLOSED IMPELLER

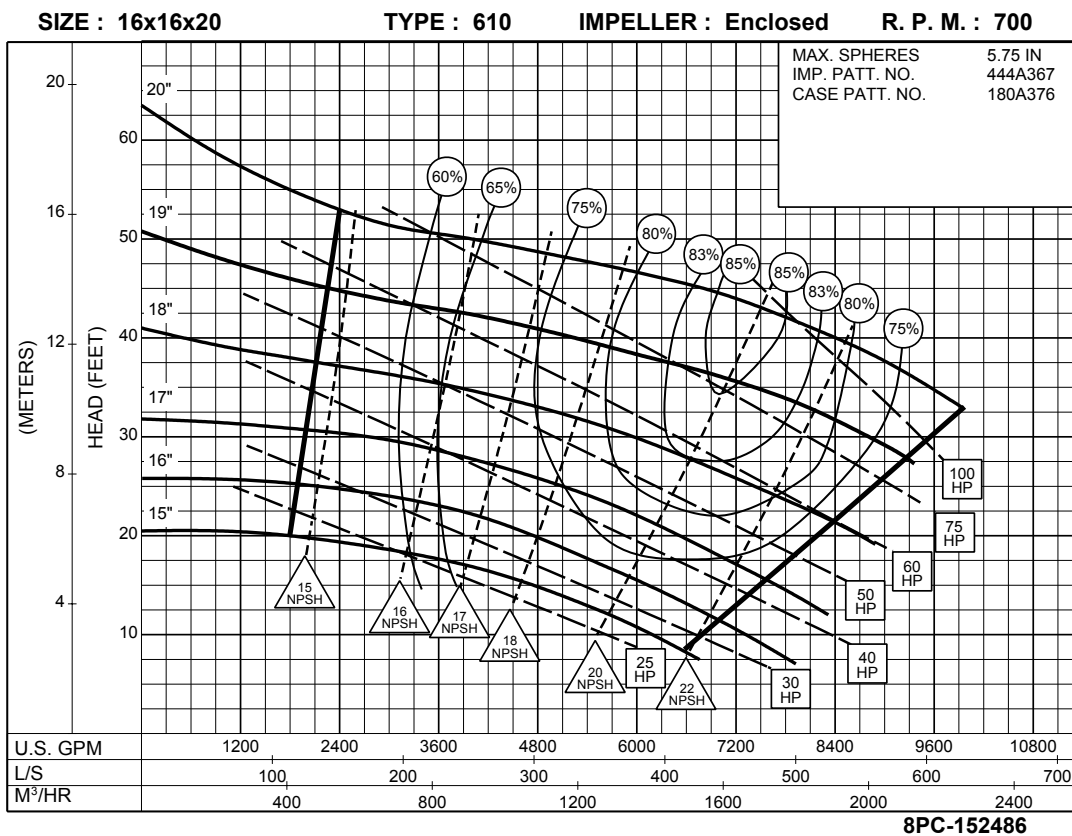
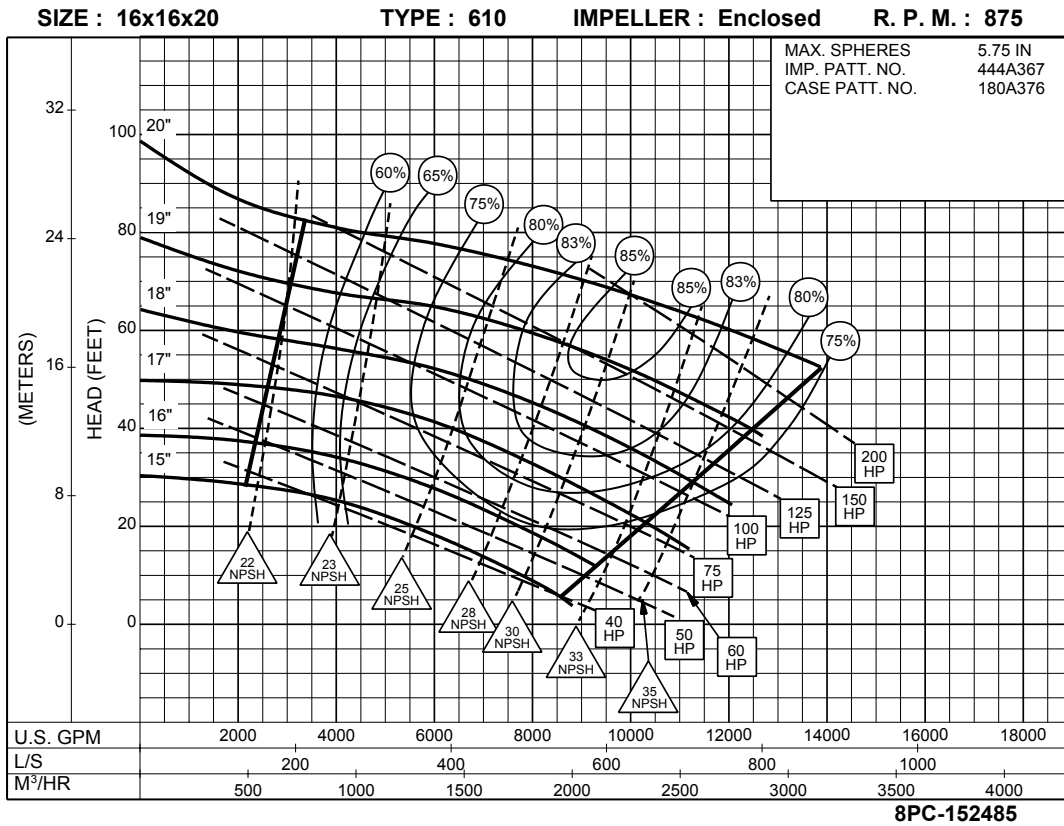

16 x 16 x 20
SERIES 610

ENCLOSED IMPELLER

SIZE : 16x16x20 TYPE : 610 IMPELLER : Enclosed R. P. M. : 585

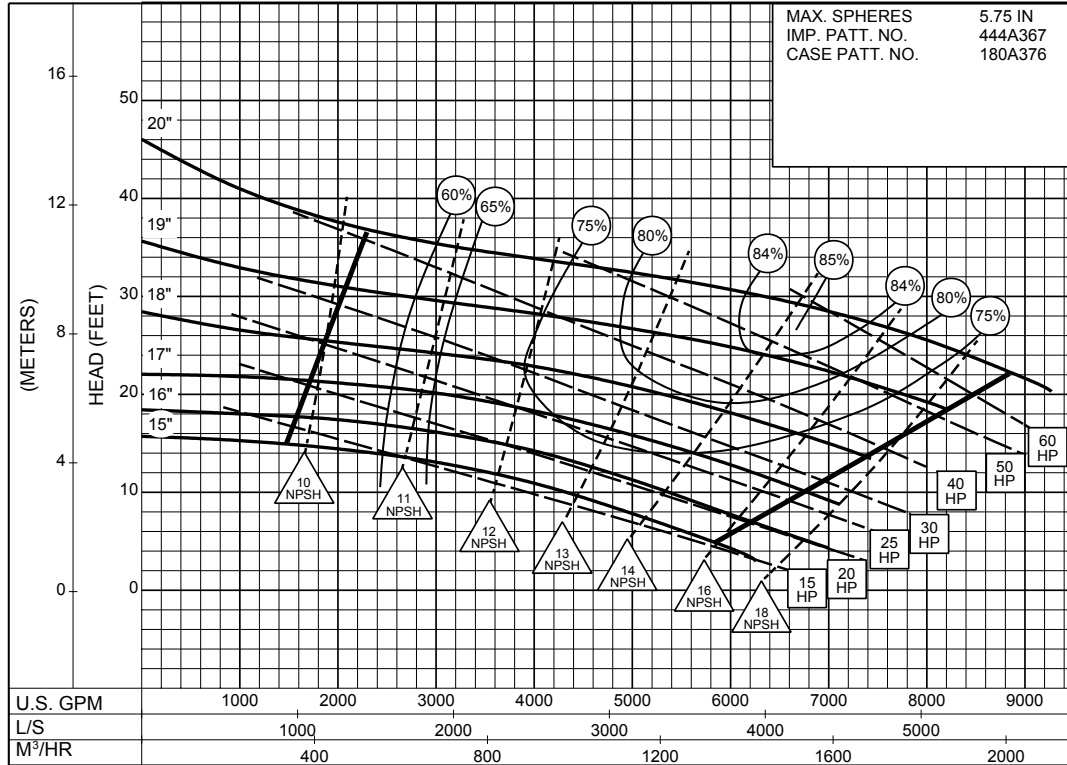

585
RPM

SIZE : 16x16x20 TYPE : 610 IMPELLER : Enclosed R. P. M. : 500

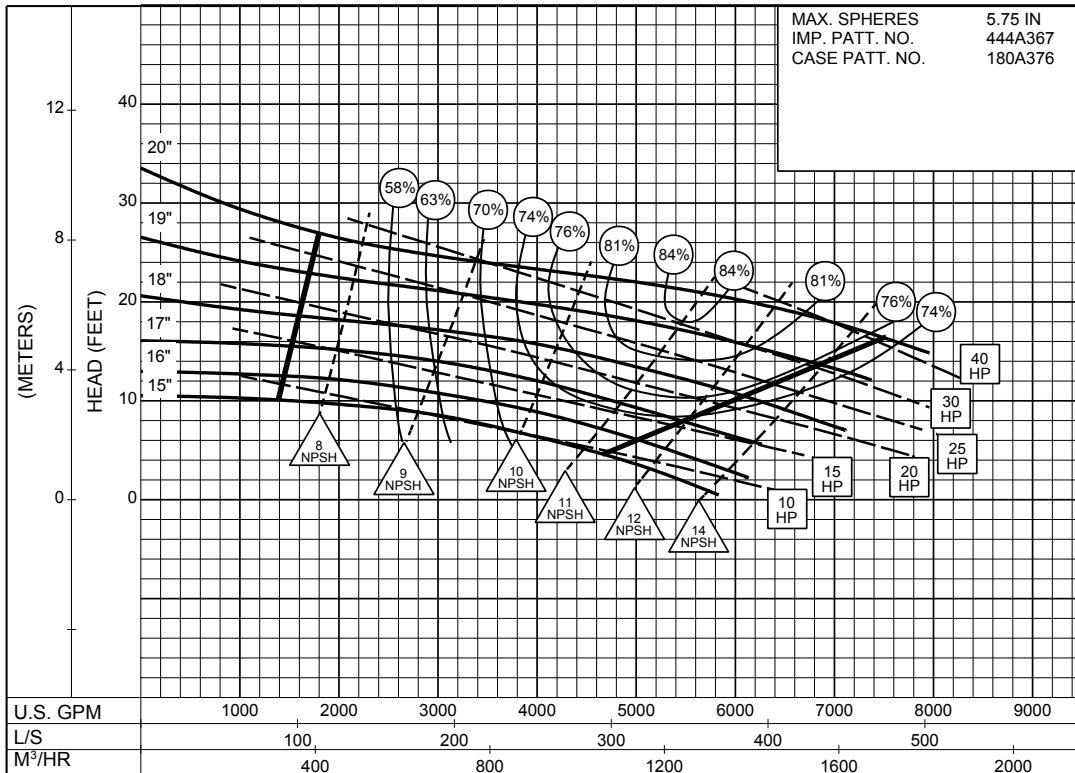

500
RPM

16 x 16 x 28 SERIES 610

ENCLOSED IMPELLER

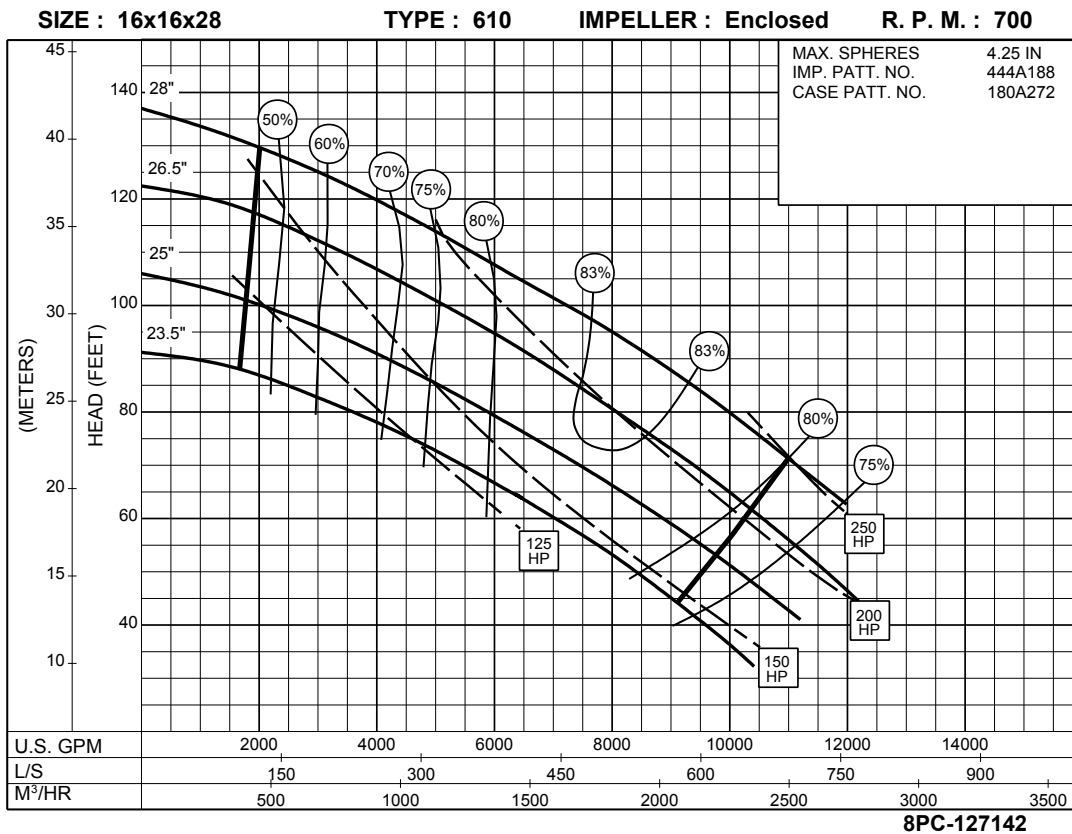
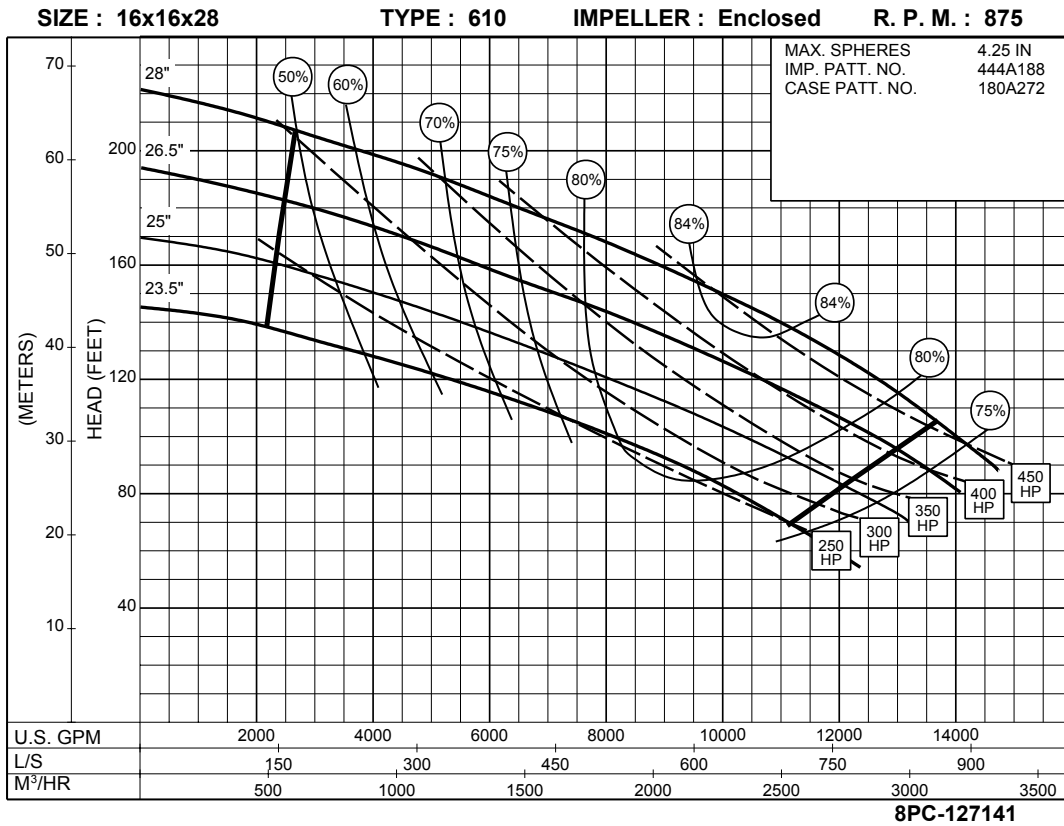

SIZE : 16x16x28

TYPE : 610

IMPELLER : Enclosed

R. P. M. : 585

MAX. SPHERES 4.25 IN
IMP. PATT. NO. 444A188
CASE PATT. NO. 180A272

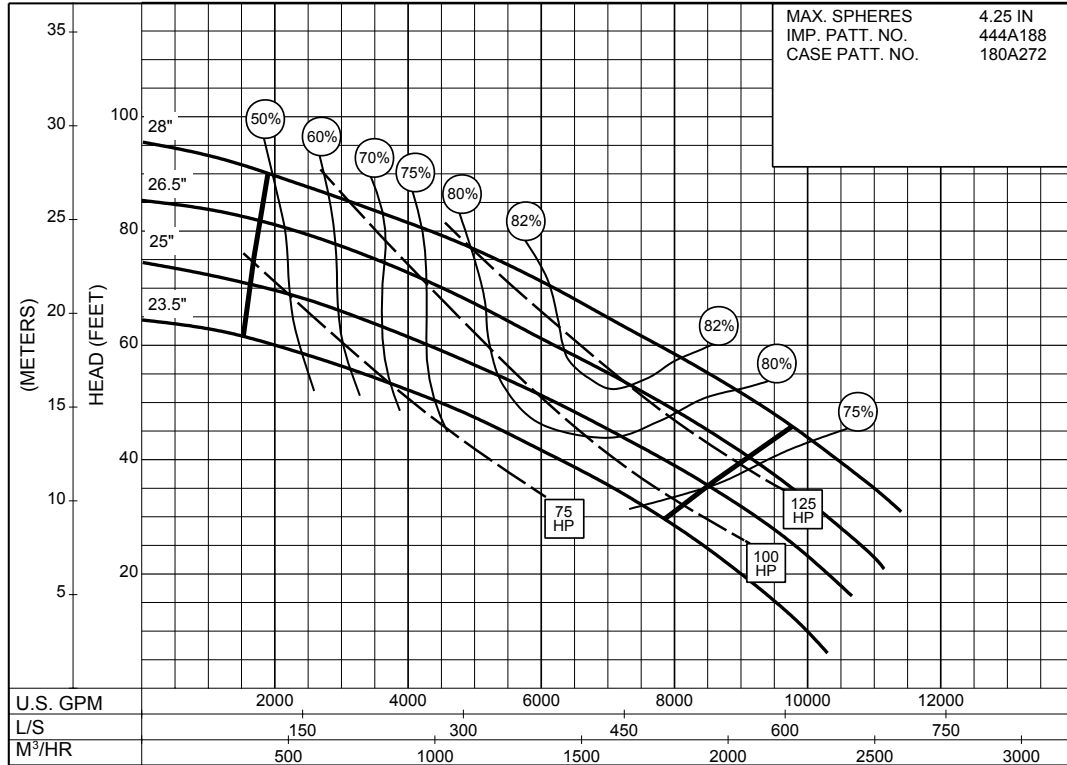

585
RPM

8PC-127143

18 x 18 x 28 SERIES 610

ENCLOSED IMPELLER

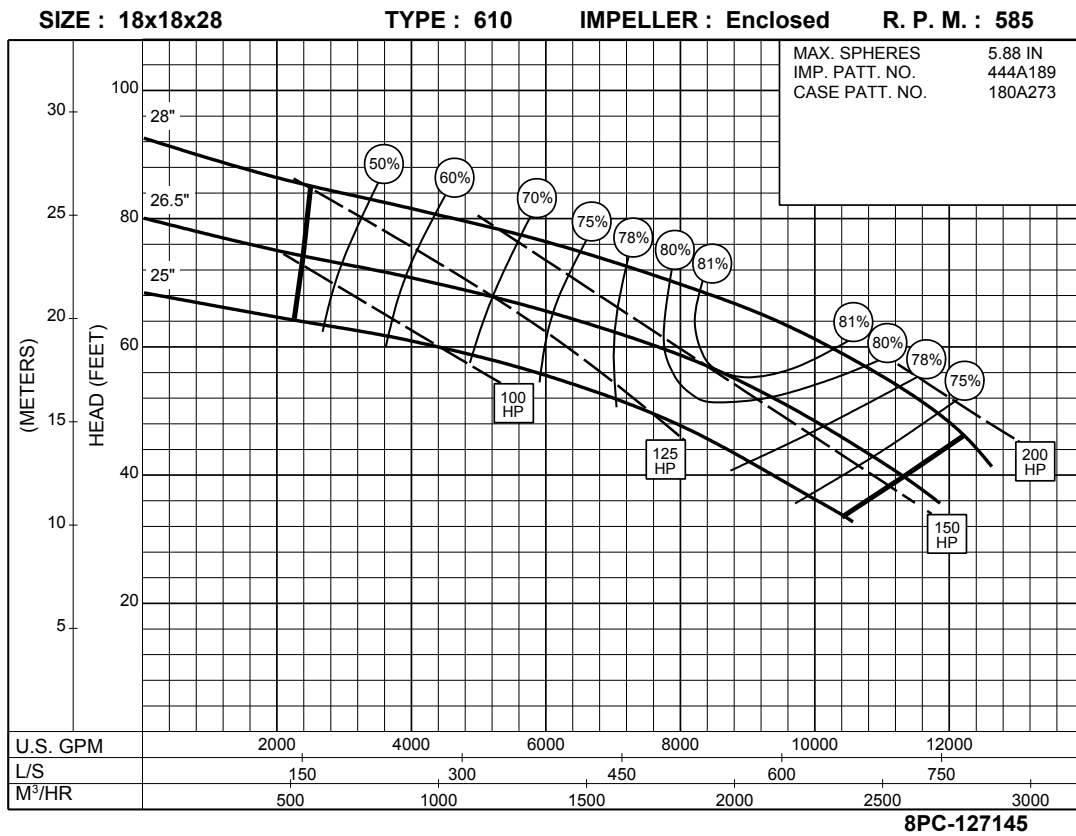
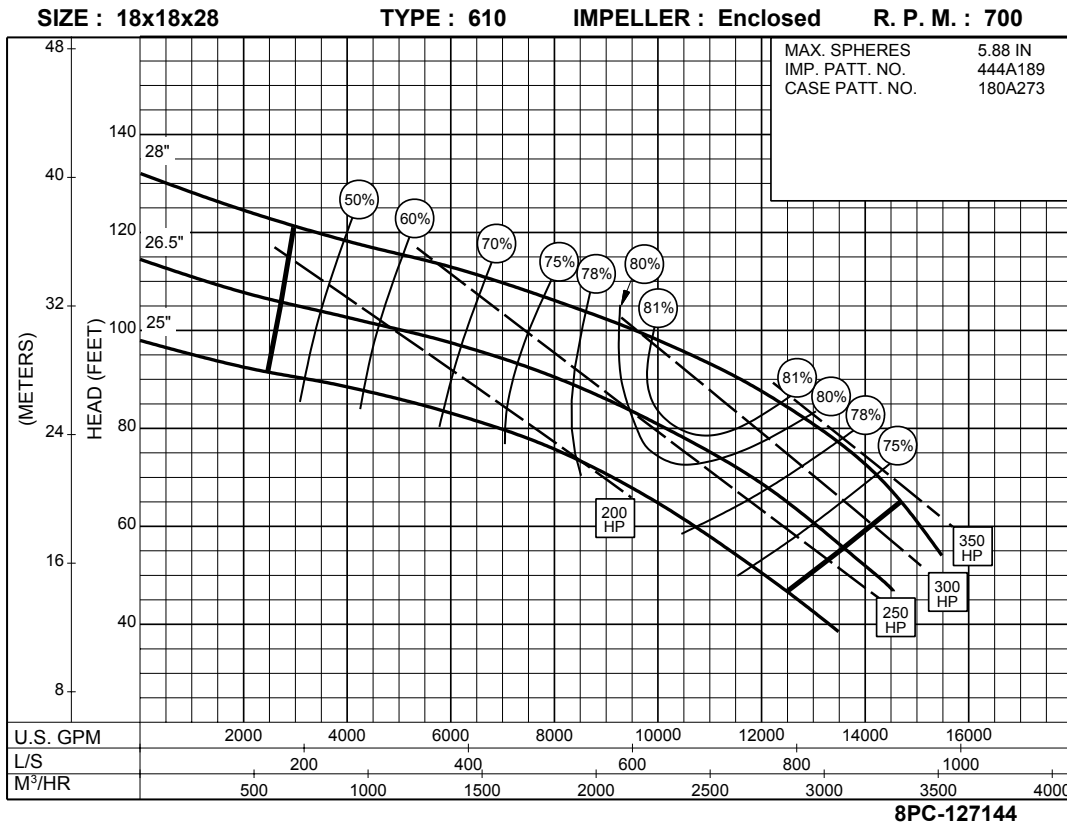

SIZE : 18x18x28

TYPE : 610

IMPELLER : Enclosed

R. P. M. : 500

MAX. SPHERES 5.88 IN
IMP. PATT. NO. 444A189
CASE PATT. NO. 180A273

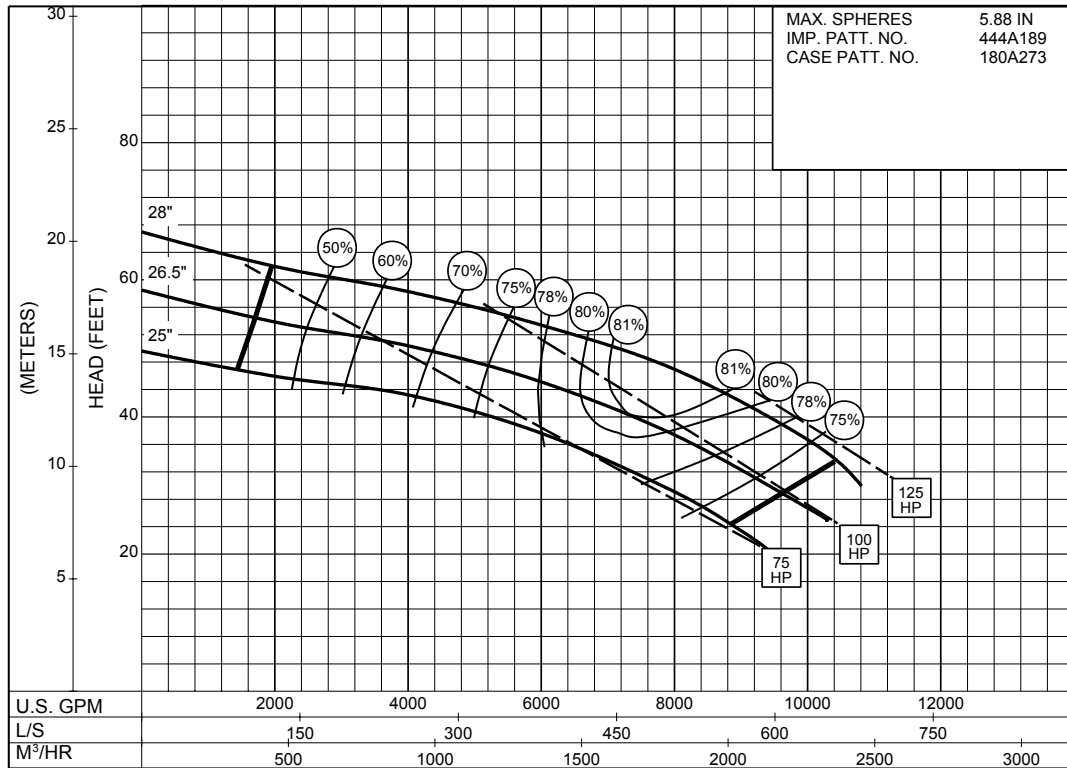

8PC-127146

20 x 20 x 28 SERIES 610

ENCLOSED IMPELLER

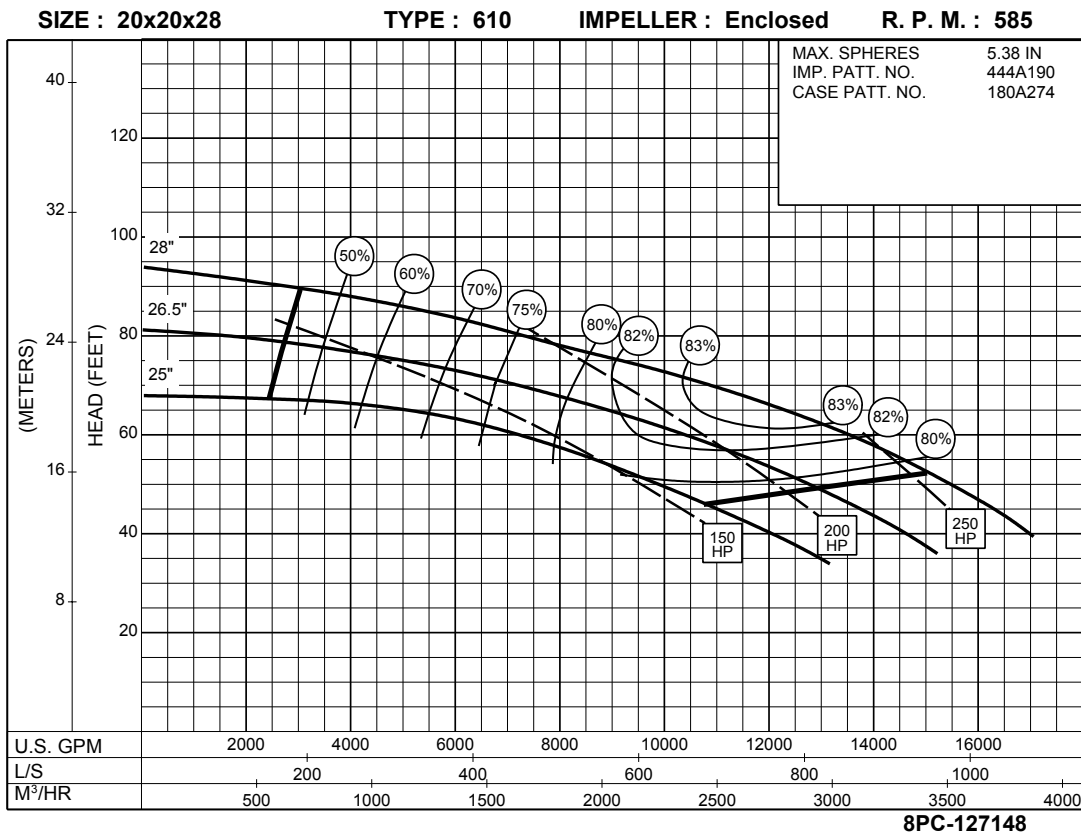
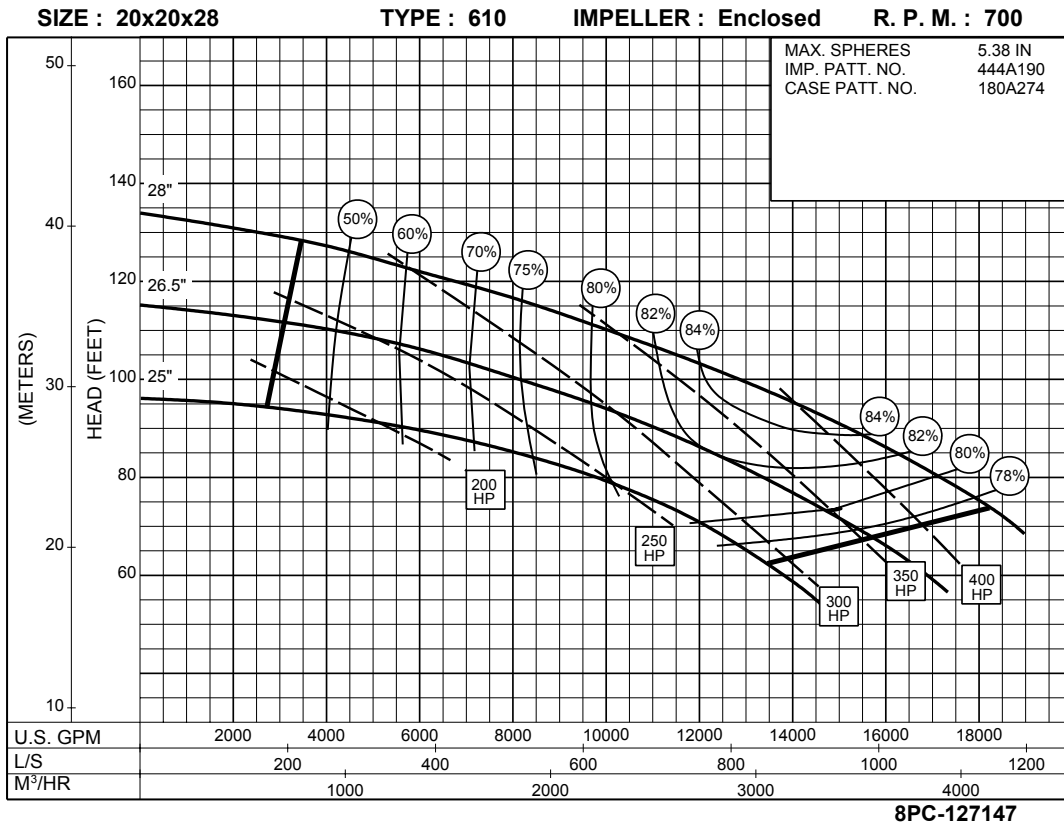

SIZE : 20x20x28

TYPE : 610

IMPELLER : Enclosed

R. P. M. : 500

MAX. SPHERES 5.38 IN
IMP. PATT. NO. 444A190
CASE PATT. NO. 180A274

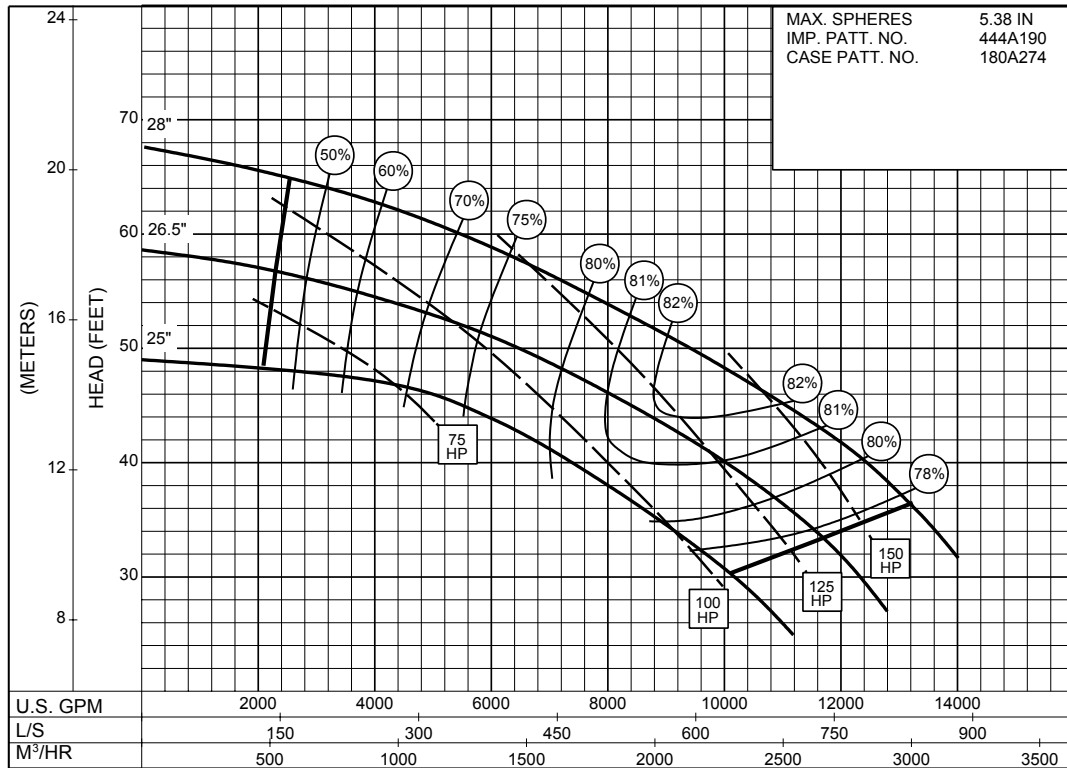

500
RPM

8PC-127149