

3 x 3 x 7 SERIES 650A

ENCLOSED IMPELLER

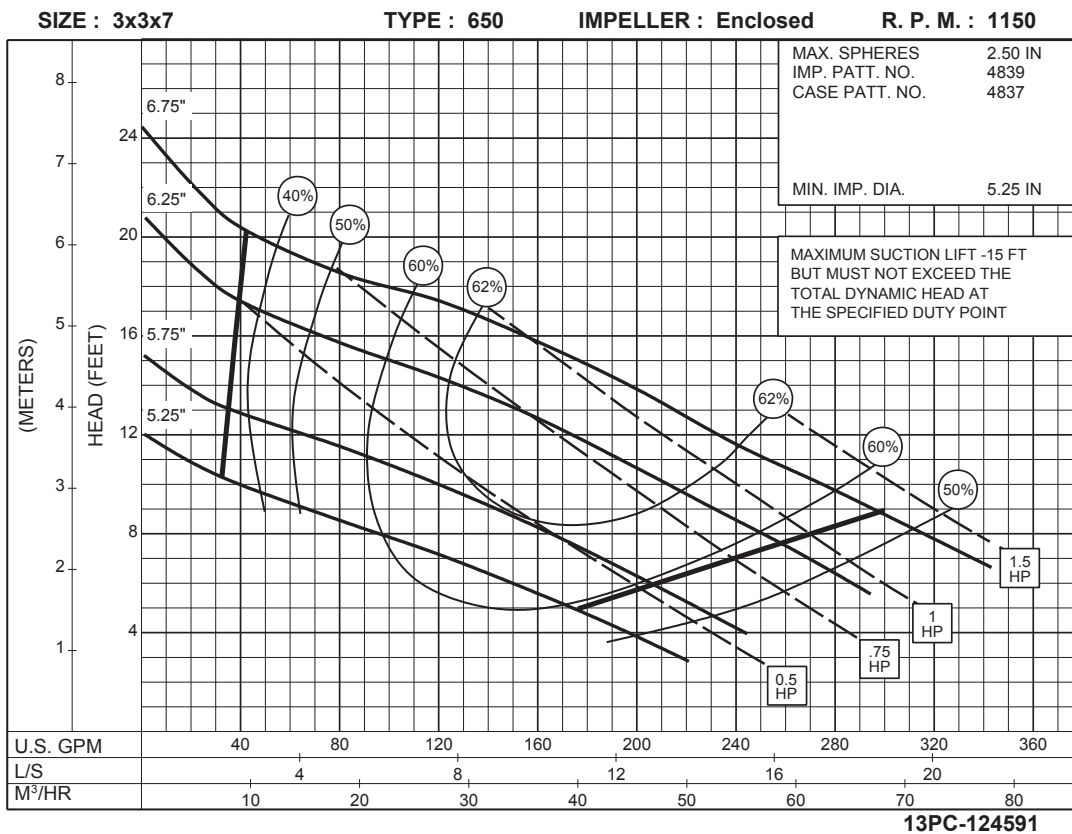
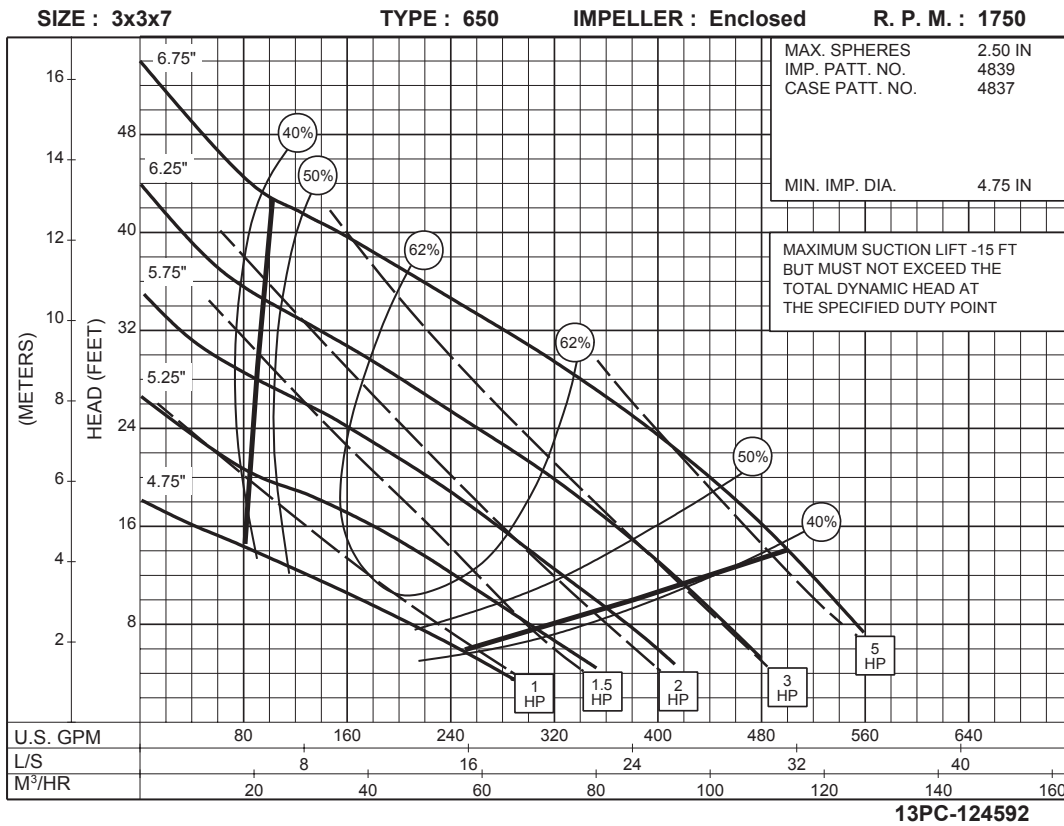

3 x 3 x 9 SERIES 650A

ENCLOSED IMPELLER

SIZE : 3x3x9 TYPE : 650 IMPELLER : Enclosed R. P. M. : 1750

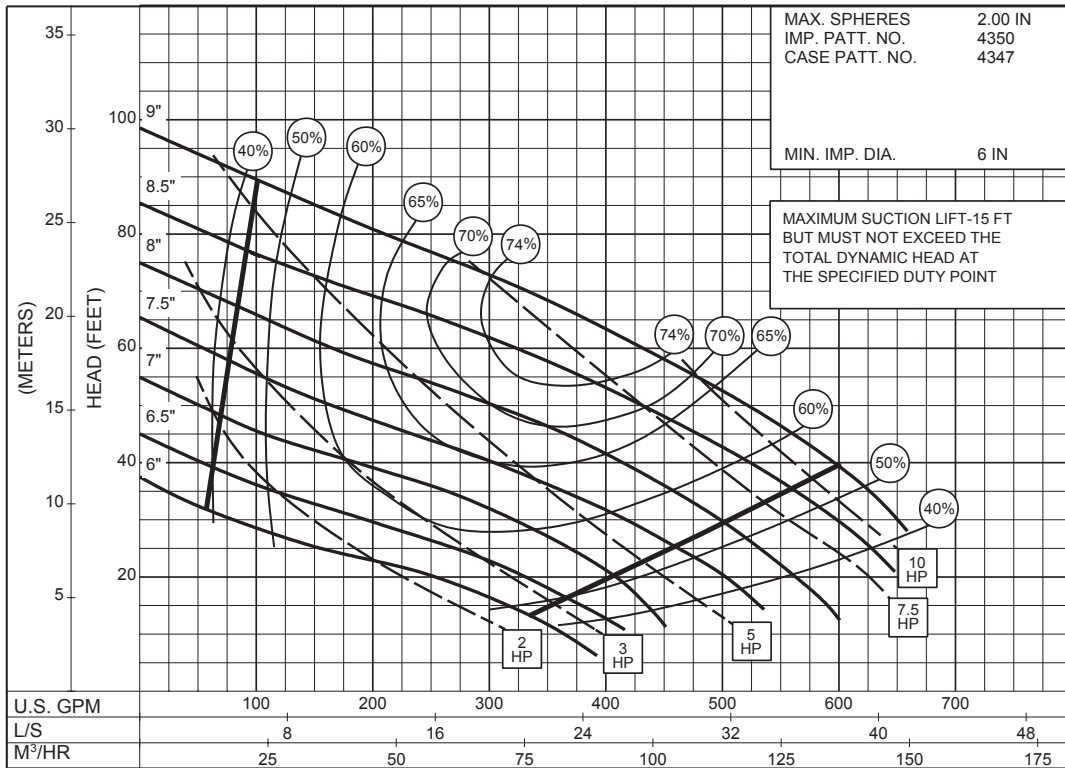

13PC-124590

1750
RPM

SIZE : 3x3x9 TYPE : 650 IMPELLER : Enclosed R. P. M. : 1150

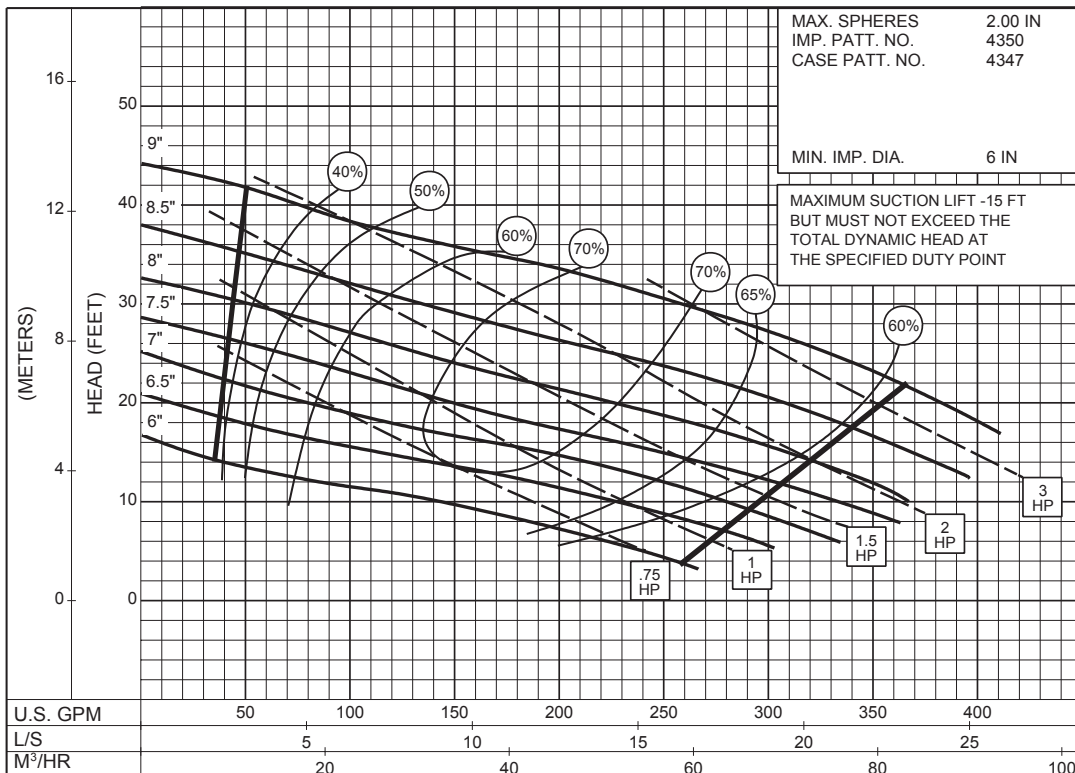

13PC-124589

1150
RPM

4 x 4 x 7 SERIES 650A

ENCLOSED IMPELLER

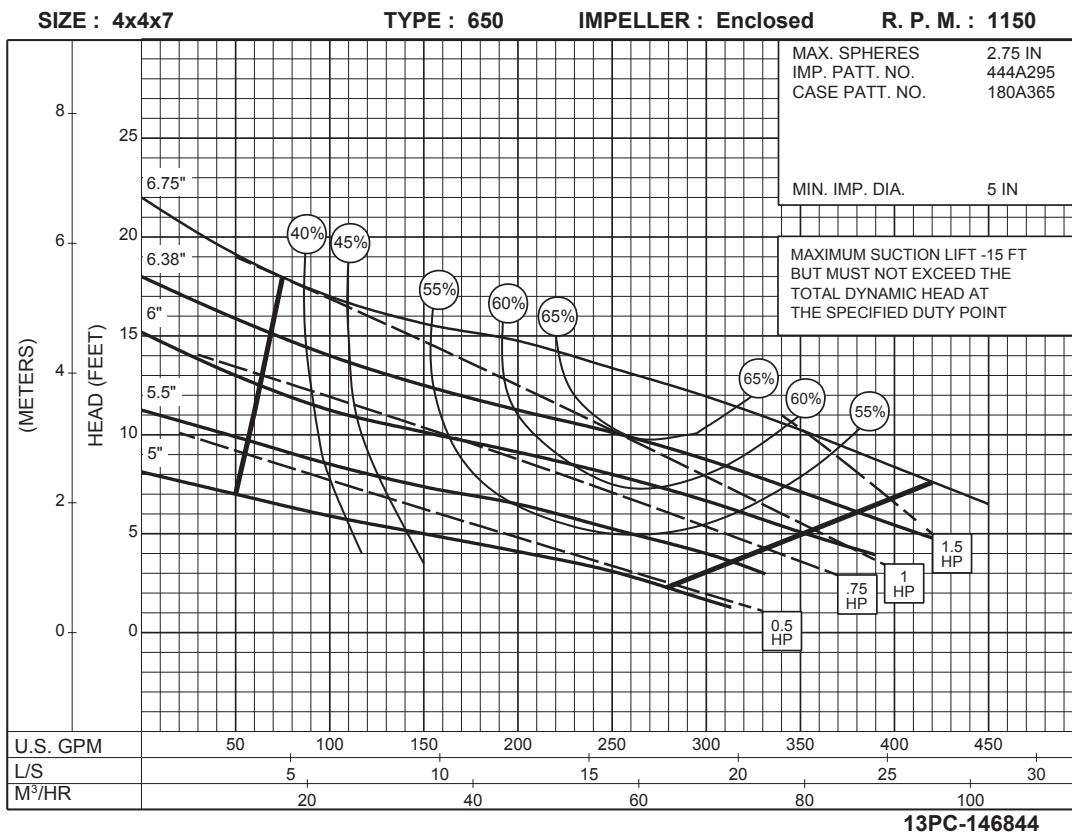
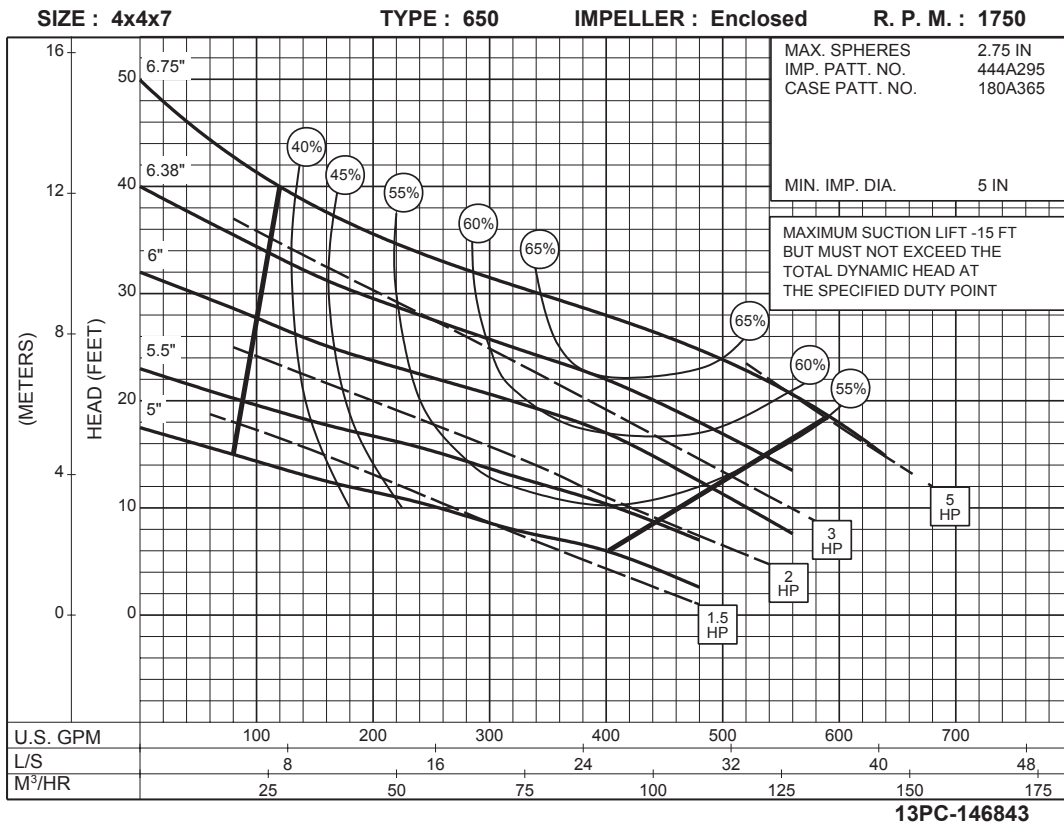

4 x 4 x 9A SERIES 650A

ENCLOSED IMPELLER

SIZE : 4x4x9A TYPE : 650 IMPELLER : Enclosed R. P. M. : 1750

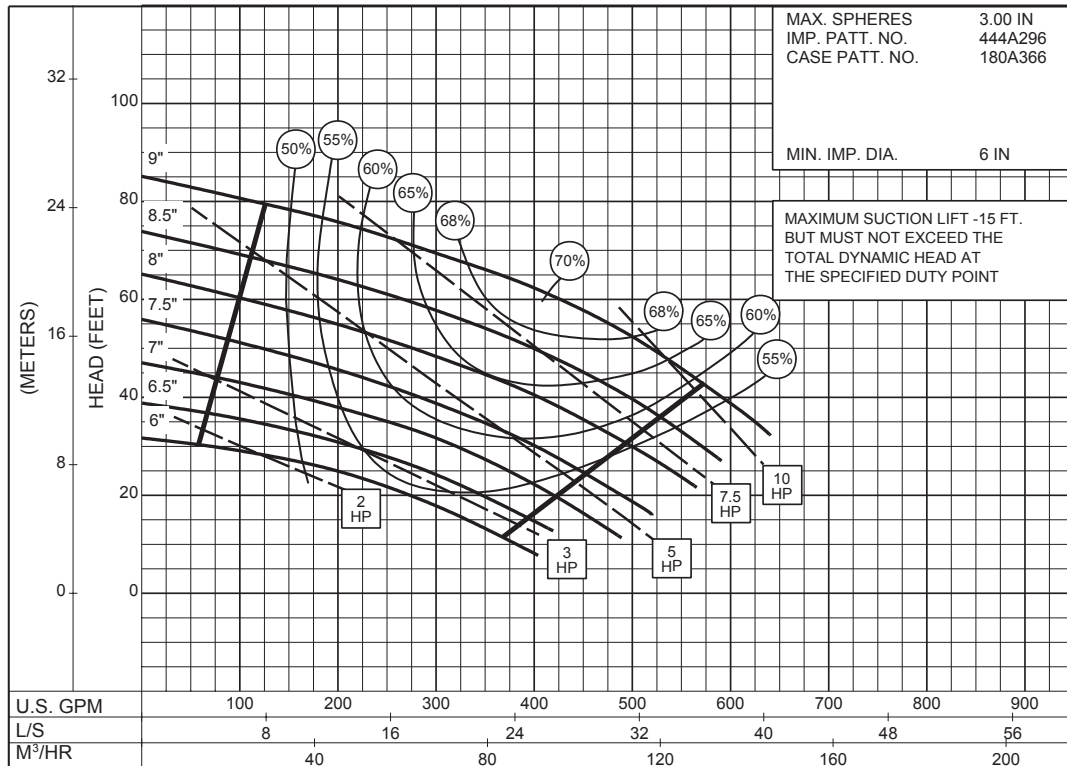

13PC-147001

1750
RPM

SIZE : 4x4x9A TYPE : 650 IMPELLER : Enclosed R. P. M. : 1150

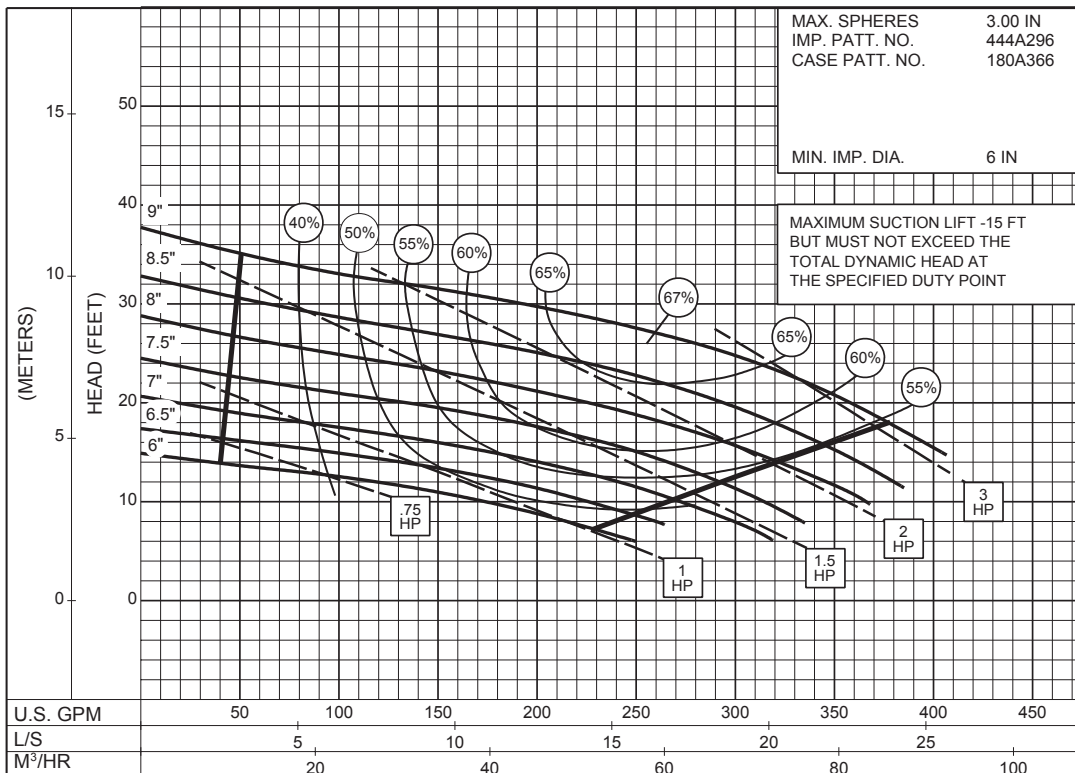

13PC-147002

1150
RPM

4 x 4 x 9B SERIES 650A

ENCLOSED IMPELLER

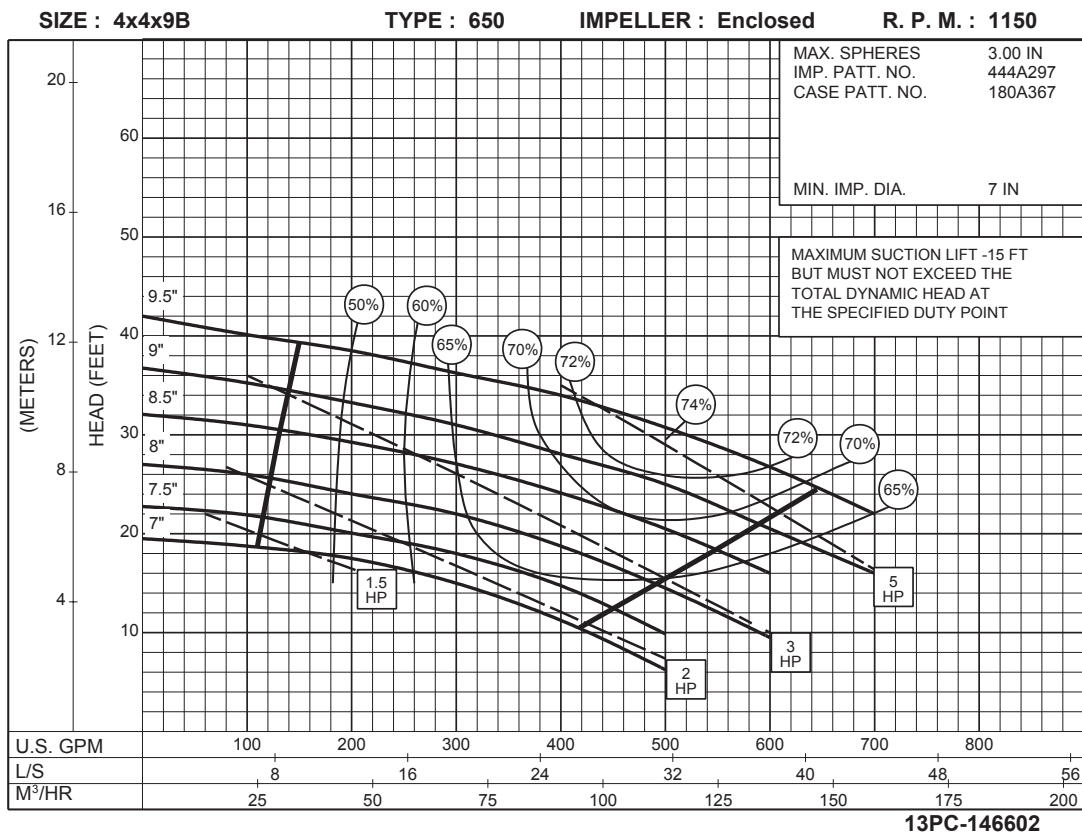
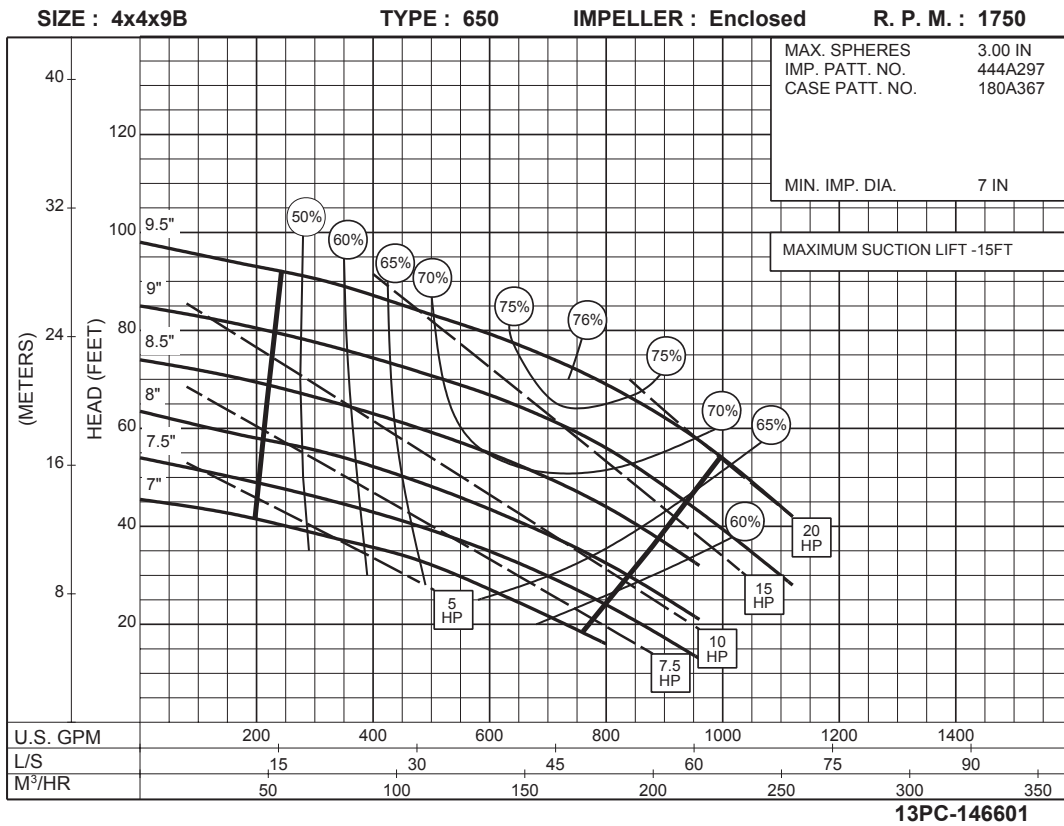

4 x 4 x 9B
SERIES 650A

ENCLOSED IMPELLER

SIZE : 4x4x9B TYPE : 650 IMPELLER : Enclosed R. P. M. : 875

MAX. SPHERES 3.00 IN
IMP. PATT. NO. 444A297
CASE PATT. NO. 180A367

MIN. IMP. DIA. 7 IN

MAXIMUM SUCTION LIFT - 15 FT
BUT MUST NOT EXCEED THE
TOTAL DYNAMIC HEAD AT
THE SPECIFIED DUTY POINT

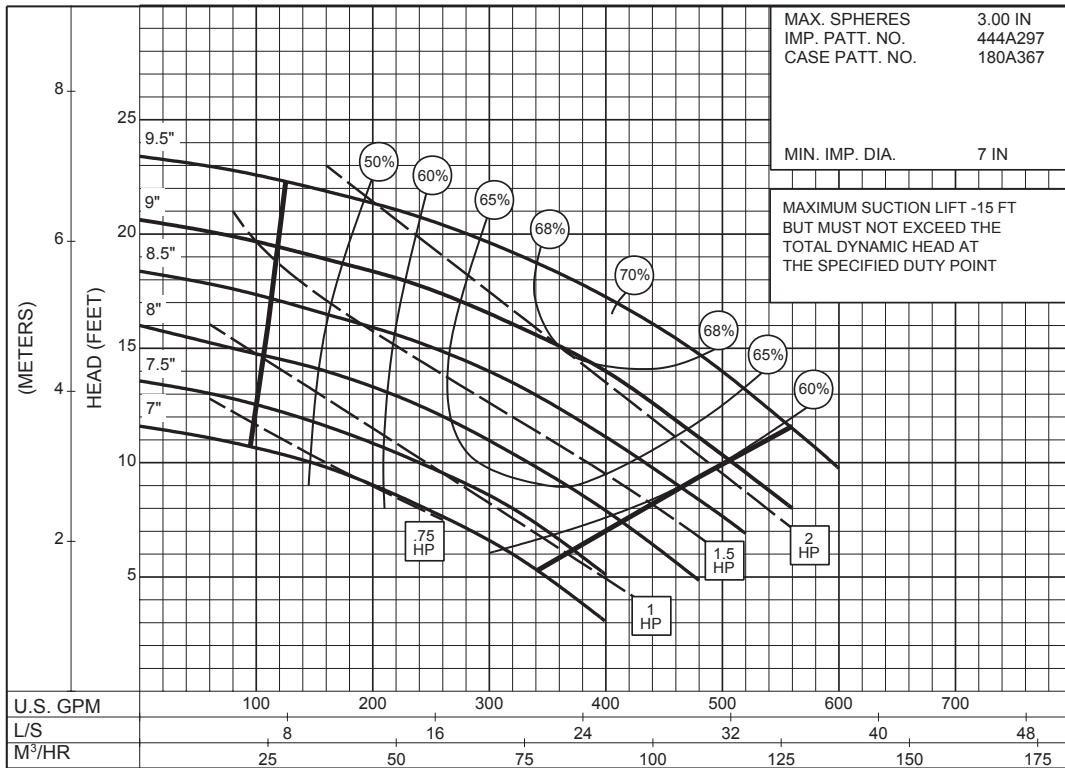

875
RPM

13PC-146603

4 x 4 x 12 SERIES 650A

ENCLOSED IMPELLER

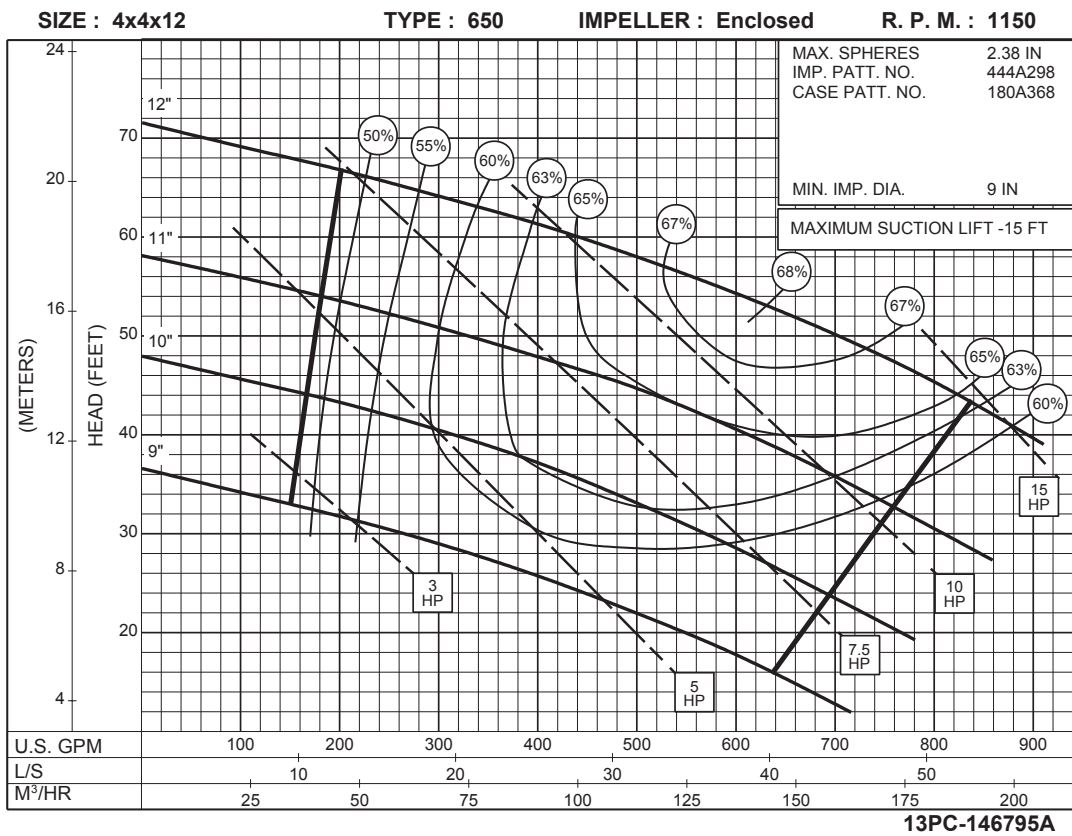
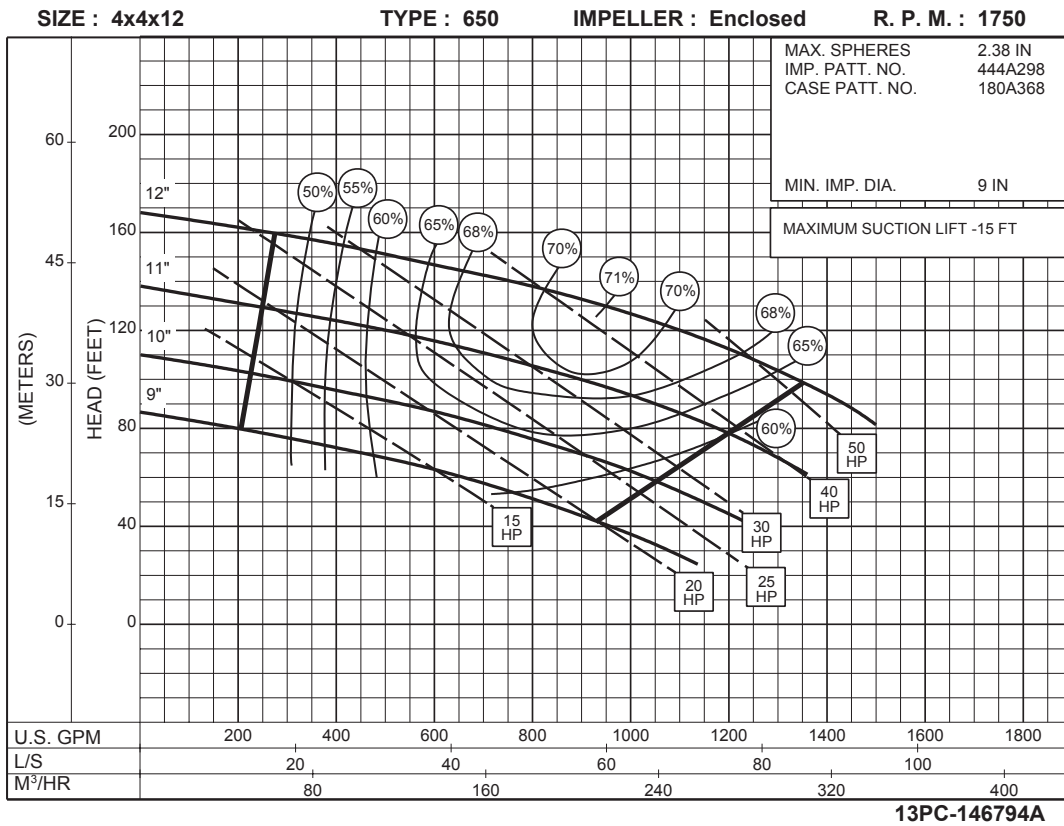

4 x 4 x 12 SERIES 650A

ENCLOSED IMPELLER

SIZE : 4x4x12 TYPE : 650 IMPELLER : Enclosed R. P. M. : 875

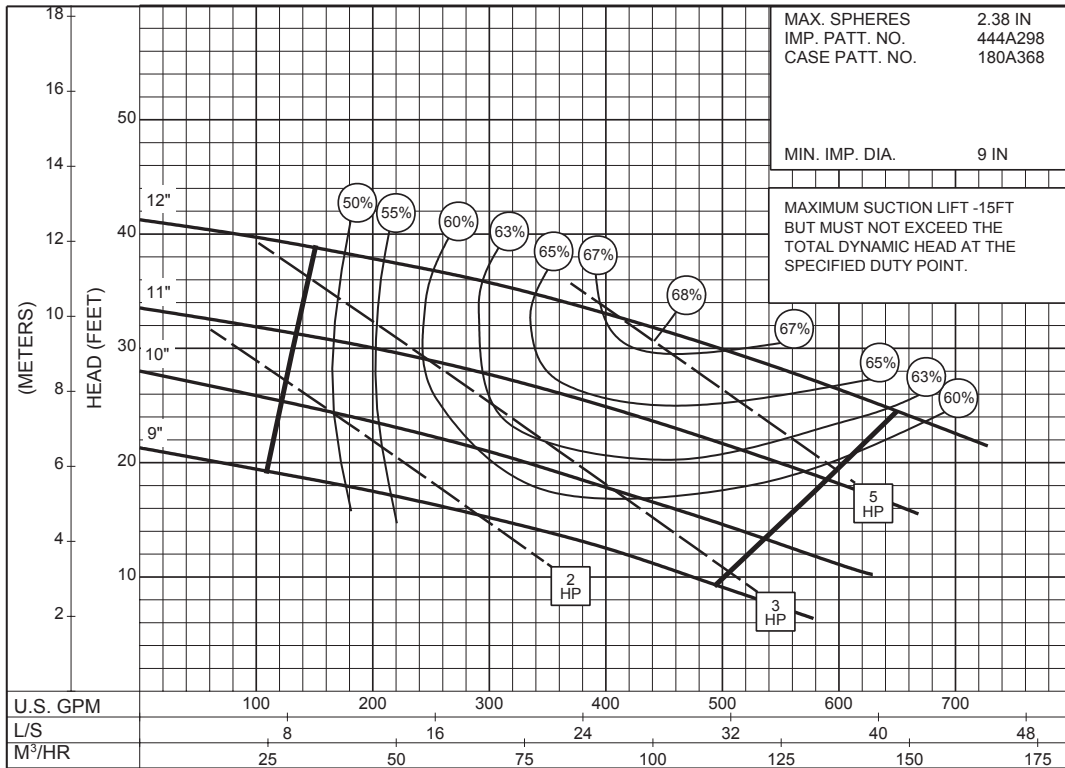

875
RPM

13PC-146796A

4 x 6 x 15 SERIES 650A

ENCLOSED IMPELLER

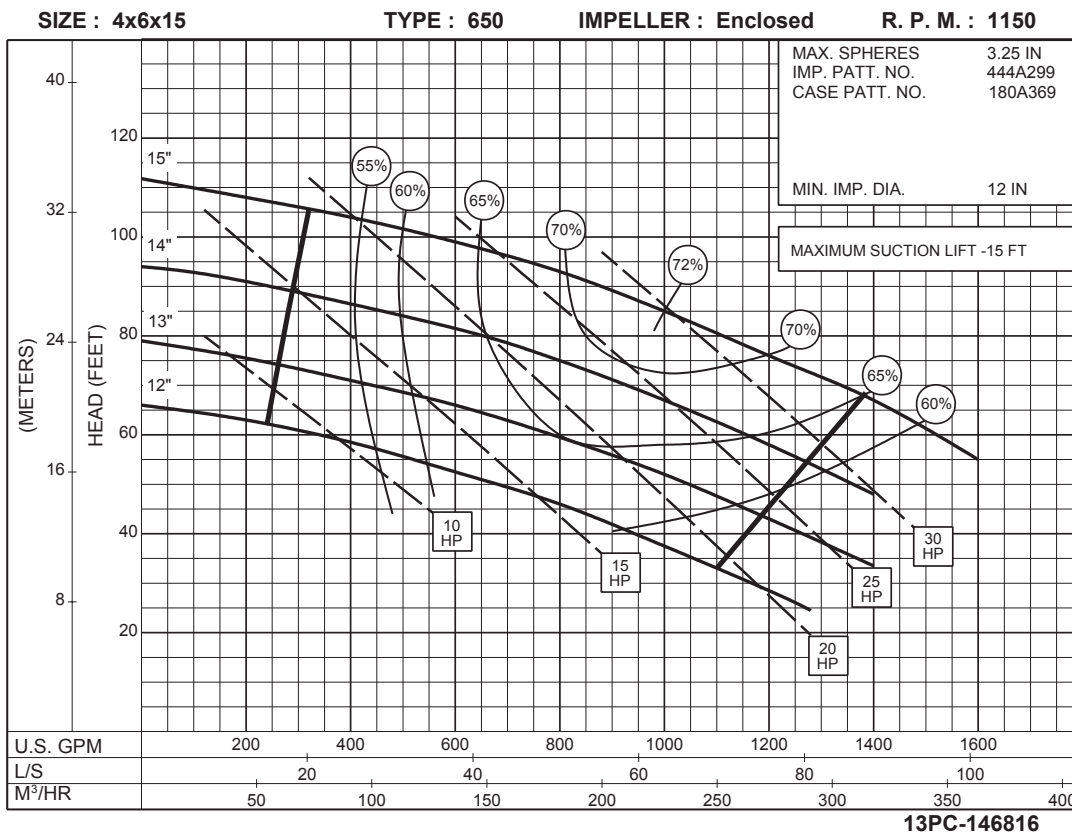
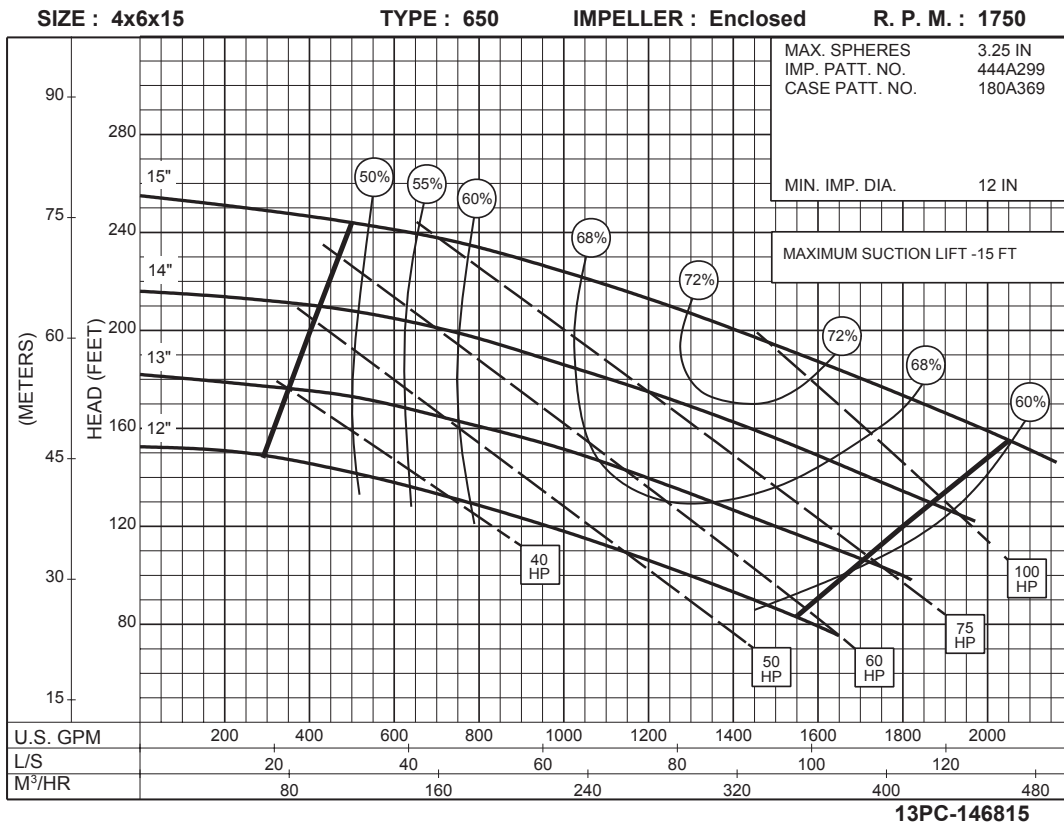

4 x 6 x 15
SERIES 650A

ENCLOSED IMPELLER

875
RPM

SIZE : 4x6x15 TYPE : 650 IMPELLER : Enclosed R. P. M. : 875

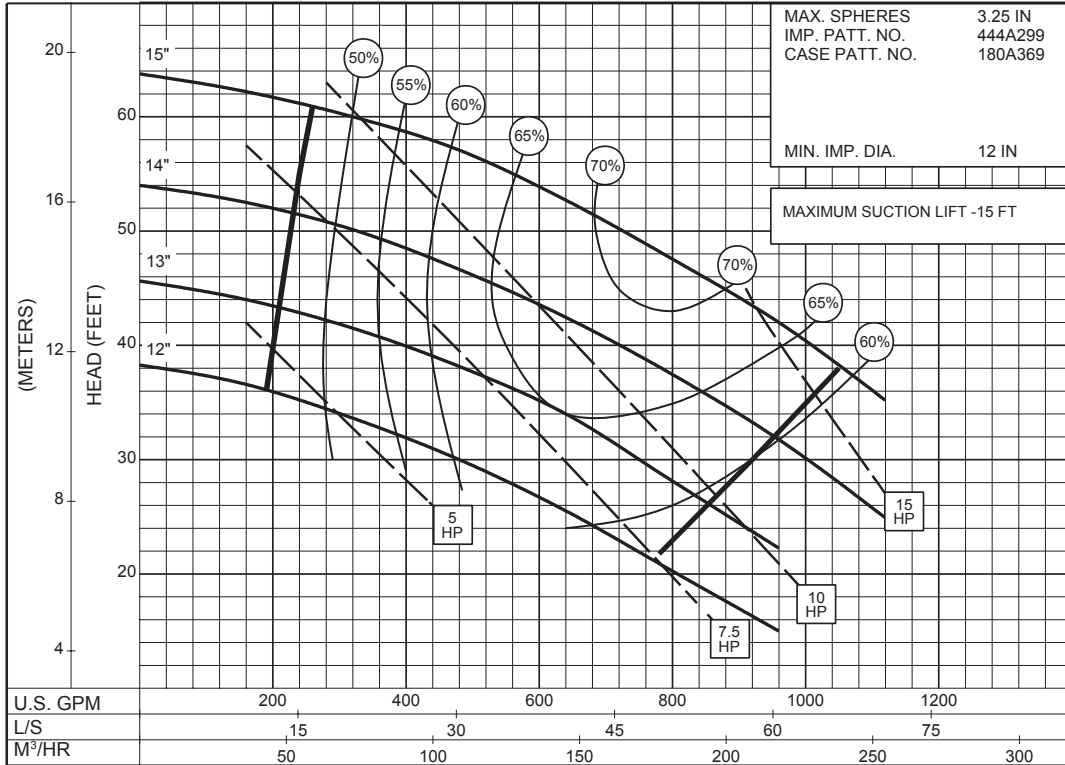

13PC-146817

700
RPM

SIZE : 4x6x15 TYPE : 650 IMPELLER : Enclosed R. P. M. : 700

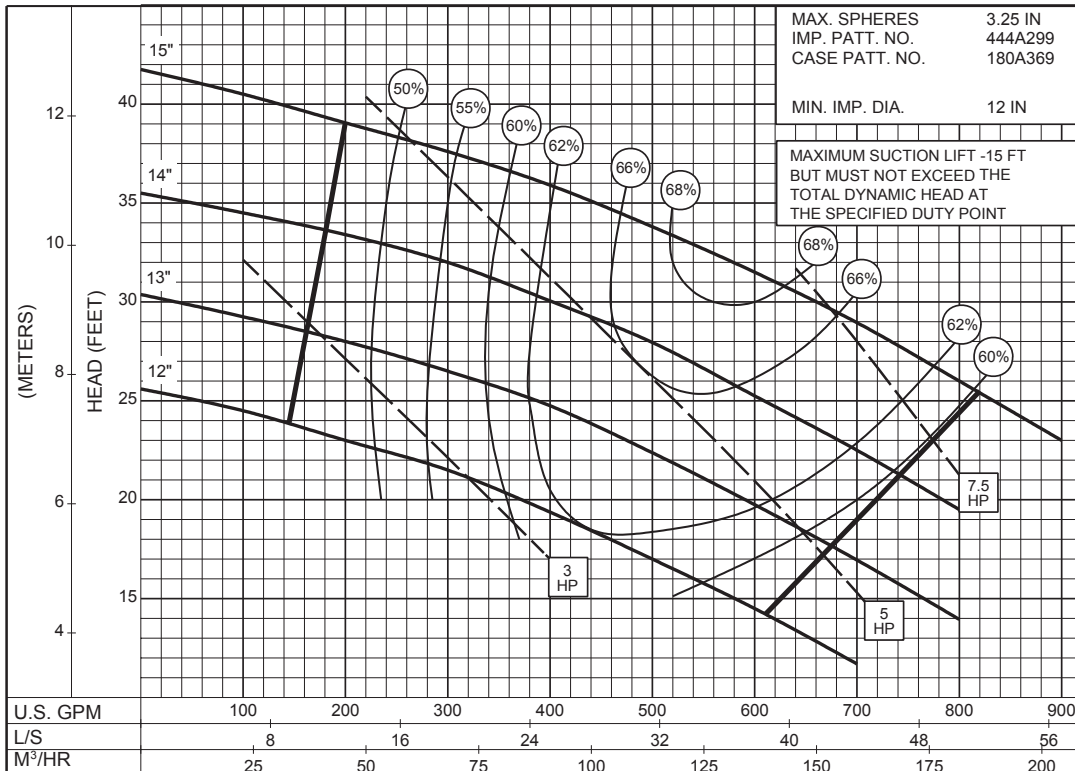

13PC-146818